

INSTALLATION GUIDE

Issue 1

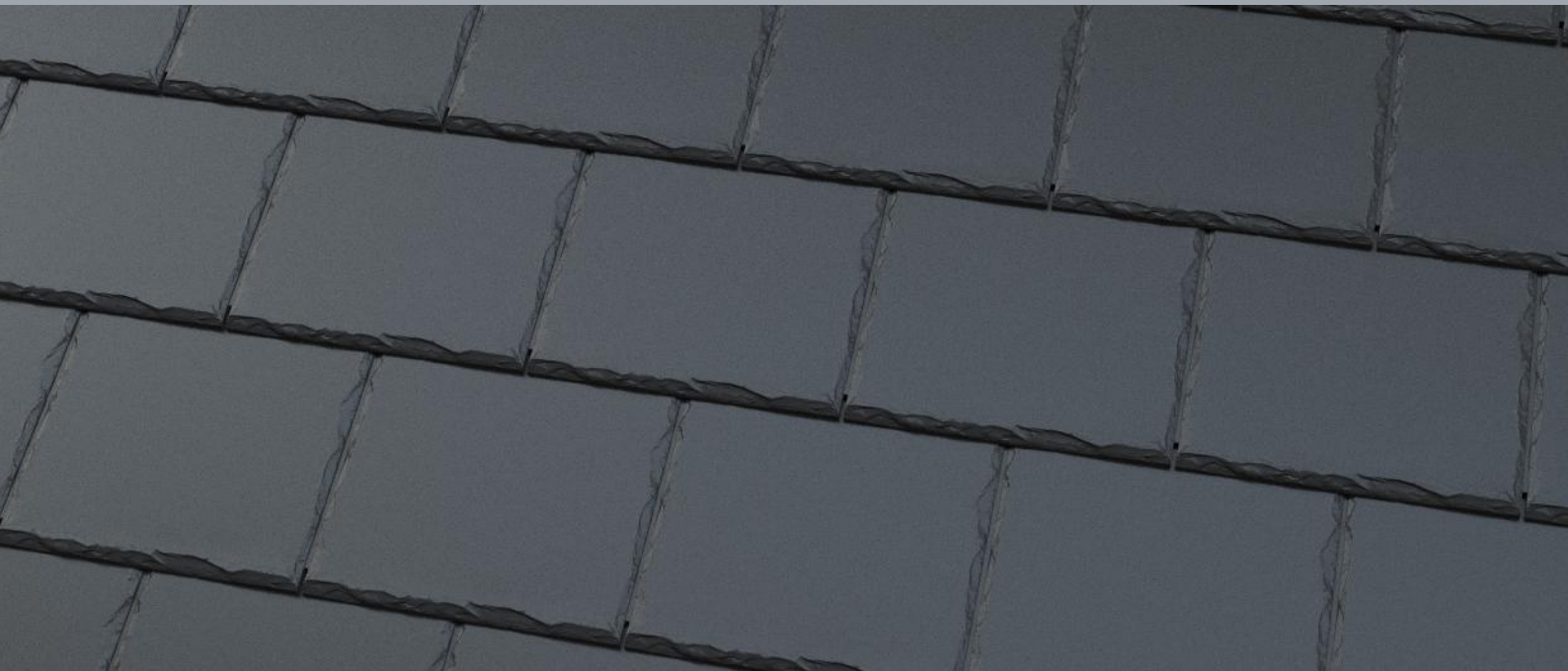

CONTENTS

1.	Technical features	3	14.	Final stages	27
2.	Technical information	4-5	15.	Installing hip roofs	28-29
3.	Envirolay test results	6	16.	Installing eaves starter rail	30
3.1.	Envirolay technical information	6	17.	Installing Envirolay	31
4.	Installation guide for Envirotiles	7	18.	Installing Envirotiles	32
5.	Setting up	8	19.	Single hip roof faces	33
6.	Ventilation	9	20.	Double hipped roof faces	34
7.	Eaves starter rail	10	21.	Ventilated ridge and hip roll	35
8.	Envirolay installation	11-12	22.	Installing the ridge	36
9.	Fitting battens	13-16	23.	Installing the hip ridge	37
10.	Dry verge installation	17	24.	Fitting the gutters	38
11.	Installing the Envirotiles	18-22	25.	Envirotile slate components list	39
12.	Abutment walls	23-24	26.	Envirotile standard components list	40
13.	Installing the ridge	25-26	27.	Envirotile standard/slate components list	41-42



BE SAFE WHEN WORKING AT HEIGHT

Ensure you conform to the latest Work at Height Regulations. For more details, visit:
www.hse.gov.uk/work-at-height

If in doubt at any stage

Please contact our Technical Support for additional support or advice.



0333 777 3047

INSTALLATION GUIDE

This step by step installation and technical guide is aimed at all new users of the Award Winning Envirotile mechanically dry fixed lightweight Roof System.

Envirotile offers unrivalled technical performance along with excellent eco-credentials. It's precision crafted design fully utilises the latest in recycled material technology which ensures every roof tile meets the strictest level of quality.

The lightweight Envirotile Interlocking Roof System must be installed in full compliance with recommendations outlined in BS:5534-2014 code of practice for slating and tiling and BS:8000-6-1990 code of practice for workmanship on building sites for slating and tiling of roofs and cladding.

ENVIRONMENTALLY SUSTAINABLE LEADING PERFORMANCE

- ▶ All Envirotile roof products are manufactured using 100% reliably sourced recycled plastic, providing the consumer with a genuine environmentally friendly roof covering
- ▶ Outstanding test results conducted by the Bre test facility to Pr EN15601 established that Envirotile roof covering provides increased performance against wind loads over that of conventional roof tiles and slates with standard clip fixings
- ▶ Fully Tested and fully compliant for both the UK BS:5534-2014 and European equivalent DD:CEN/S 15087 External Fire Exposure Roof Test conducted by Exova to BS476-3 – EXT.S.AA
- ▶ External Fire Exposure Roof Test conducted by Exova to DD CEN/TS 1187 test 4 – B Roof t4
- ▶ Maintains full integrity and provides a leading performance against wind uplift loads from a minimum low roof pitch of 12.5°
- ▶ Durable and robust, minimising breakages normally experienced during the roof installation process
- ▶ Resists mould, moss and fungus due to the non-porous attributes of polymer material
- ▶ Provides future generations with a genuine polymer recycled application at the end of life, assisting with considerate constructors' initiatives

ENVIROTILE: BENEFITS THAT REDUCE OVERALL BUILDING COSTS

- ▶ Designed to provide a simple and cost effective roof covering that is fully mechanically dry fixed
- ▶ Envirotile is a lightweight roof product weighing an average of just 7.8 kilos per square metre in contrast with conventional cement or natural slate products that can weigh on average 50 kilos
- ▶ Less weight results in cheaper transportation, reduced CO² transport emissions and less structural requirement on roofing supports
- ▶ No additional roof tiles required to accommodate top and bottom eaves courses due to the innovative patented design, providing customers with reduced material cost

ENVIROTILE: GENUINELY SUSTAINABLE

- ▶ Manufactured from environmentally sustainable products otherwise destined for landfill
- ▶ Provides an environmentally friendly building roof product that genuinely provides a great application for reusable plastic
Complies with the Code for Sustainable Homes
<http://www.breeam.org/index.jsp>
- ▶ Offers a genuine alternative to meet the growing public demand for more sustainable build options
- ▶ Completely recyclable at the end of life

ENVIROTILE: MORE SECURE

- ▶ Virtually unbreakable; interlocks in eight places, making it significantly more vandal and burglar proof

1. TECHNICAL FEATURES

1.0

TOP VIEW



UNDERSIDE VIEW

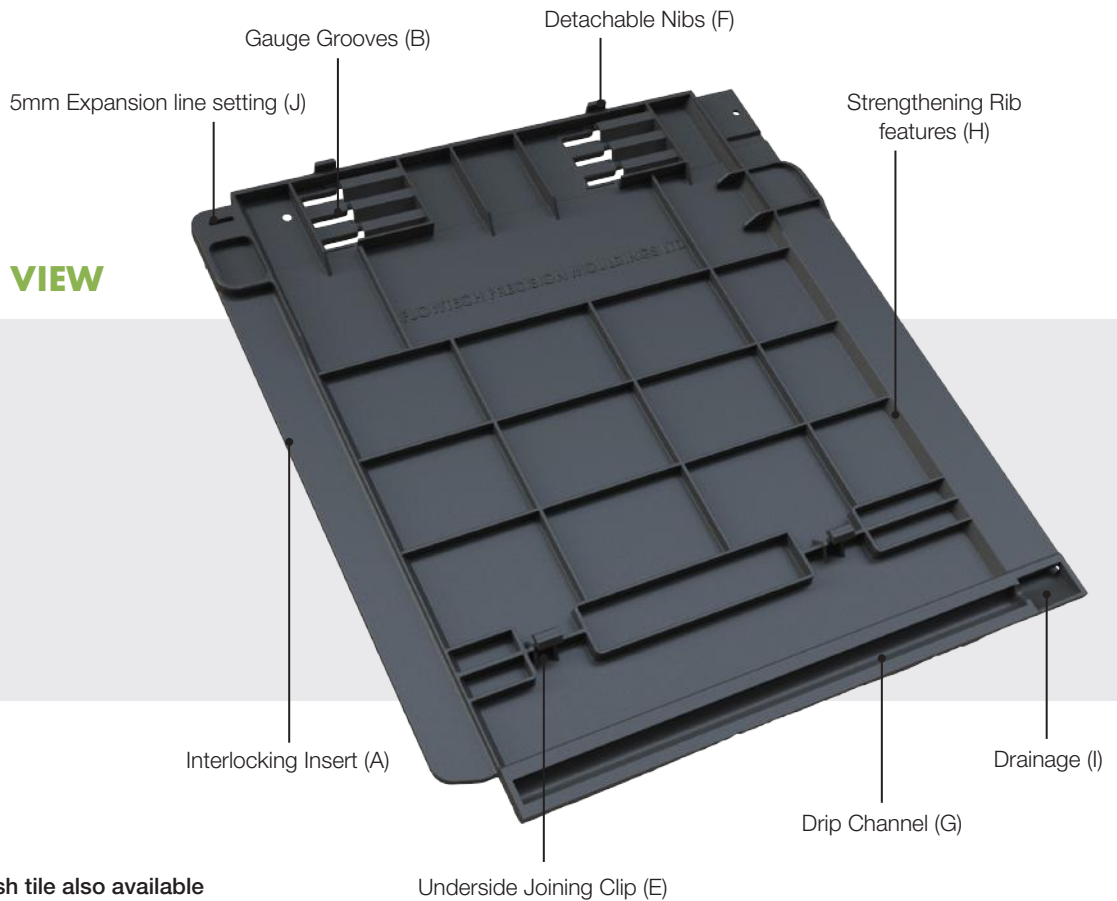

Note: Standard finish tile also available

2. AT A GLANCE TECHNICAL INFORMATION

2.0

Envirotile Composition	Manufactured to BS:9001 for quality assurance. Injection moulded using 100% of UK reliably sourced reprocessed Polypropylene
Roof Tile/Slate colour	Slate range: Terracotta/Brown/Slate Grey/Anthracite Grey Standard range: Terracotta/Brown/Slate Grey/Anthracite Black
Gauge Recommended Setting	Head Lap
12.5° - 22.5° (Low Pitch) 250mm Gauge	110mm
22.5° - 90° 265mm Gauge	95mm
22.5° - 90° 280mm Gauge	80mm
Coverage per Square Metre	
At 280mm gauge	11.9 tiles
At 265mm gauge	12.6 tiles
At 250mm gauge	13.4 tiles
Envirotile Weight (single tile)	645g
Easy to carry pack (10 tiles)	6.45 kg
Suitable Roof Pitch	12.5° to 90° (vertical)
Fixing batten to rafter - recommendations	Graded battens to be used 38mm x 25mm for 450mm rafter centres 50mm x 25mm for 600mm rafter centres
Batten fixing nails to BS:5534 - 14	65mm x 3.35mm
Envirotile fixing to BS:EN1202-3	Every tile to be secured and fixed
On normal pitch of 25° or over	30mm x 3.35mm stainless steel annular ring shank
Low pitch fixing from 12.5° to 25°	30mm x 4mm countersunk stainless steel screw
Envirolay Bre Certified 13859-1 and BS:EN 12310-1	Recommended droop allowance of 15mm between rafter centres x 3 recommended nail fixings per rafter overlap 150mm for each course
Bond	A half bond using a cut half starter tile at verge - similar in appearance to a double lap tile or slate bond when laid to roof
Expansion gap between tiles	5mm (moulded guide line to assist installer)
Screw Type on shallow pitches	Always use S/Steel screw fixings on roof pitches below 25°
Cutting of Envirotile	No dust pollution is emitted during the cutting process, the use of a chalk line to determine straight edge cutting is strongly recommended and will be extremely beneficial in use with valley, hip and gable end detail

Ventilation: Universal fascia products used in conjunction with the Envirotile roof system must conform to recommendations provided in BS:5250/2016.	At fascia on roof pitches above 15° 10,000mm of airflow per metre run is recommended for use. On roof pitches below 15° 25,000mm of airflow per metre run is required for use.
Packaging	720 x single tiles supplied shrink wrapped on a wooden pallet consisting of 72 packs of 10 x tiles. 280 x double tiles consisting of 28 packs of 10 x tiles
Storage conditions	Dry flat surface area required for storing pallets
Fixing in freezing conditions	Roof tile installation not to be carried out below 4°C
Recommended universal dry fix products to be used	GRP Valley trough GRP Abutment Flashing
Dedicated Envirotile dry fix verge and ridge products	Must be genuine Eurocell manufactured and supplied parts



Eurocell reserves the right to alter any of the elements quoted in the above specification without prior notice. Please note that the above information is given in good faith and should be considered as a guide only, if any values in this specification are of critical importance then we strongly recommend the user arranges independent testing themselves. Test methods mentioned are considered as guides only, actual methods may differ slightly in practice. Suitability of the product for all applications is at the discretion of the user, as are any potential patent infringements relating to specific applications.

3. ENVIROLAY TEST RESULTS

3.0

- ▶ Fire Resistant
- ▶ For Use in all UK Zonal Areas 1-5
- ▶ Fully Bre Tested to BS5534 Annex A
- ▶ Fully Exova Tested with Envirotile to DD CEN/TS 1187 test4 –Brooft4
- ▶ Suitable for use on all Cold or Warm Roof type Structures

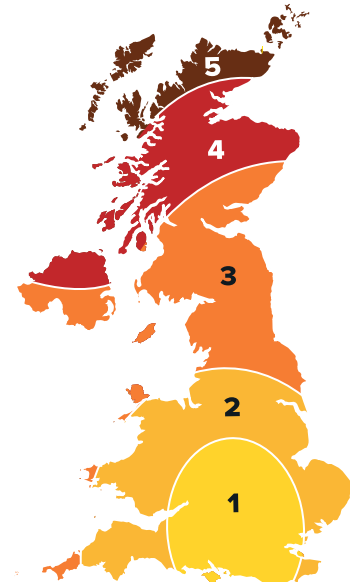

Summary of test results for wind uplift resistance

of Envirolay underlay to BS 5534-2014 Annex A Conducted by Bre Report number : P101133-1000 Issue 2

Envirolay is suitable for use in all 5 UK wind pressure zones

Underlay Name	Geographical Wind Zone		
	345mm Batten Gauge Battened Lap	250mm Batten Gauge Battened Lap	345mm Batten Gauge Taped Lap
Eurocell Envirolay	Zones 1 to 5 >2040	Zones 1 to 5	Zones 1 to 5 >4500

3.1 ENVIROLAY TECHNICAL INFORMATION

3.1

Finished Fabric	Units	Value	Tolerance
Weight	g/m ²	475	±5%
Thickness	mm	0.4	±5%
Useable width (standard)	mm	1300	±5%
Roll Length (standard)	mtr	25	
Maximum operating temp.	°C	220*	
Colour/Description	Waterproof/Grey coating both sides		
Roll Weight (standard)	kg	15.4	±5%
Base Fabric Construction	Units	Value	Tolerance
Weight	g/m ²	425	±5%
Weave pattern		4H Satin	
Construction			
Warp	per cm	19.2	±5%
Weft	per cm	11.2	±5%
Yarn count			
Warp	Tex	EC9 136	
Weft	Tex	EC9 136	
Treatment/Coating Details	Units	Value	Tolerance
Weight	g/m ²	50	±10%
25g/m ² Grey silicone on each side.			

* Maximum continuous operating temperature is 220°C, short periods up to 250°C
Base fabric will withstand 550°C (unstressed), melting point > 800°C.



DUO PLUS TAPE (ENVTAPE)

Use Duo Plus tape to seal the overlap layers to provide added protection against high wind uplift loads during full exposure.

4. INSTALLATION GUIDE FOR ENVIROTILES

4.0

This installation guide is aimed at all new users of the Envirotile system - builders, installers and self builders. It is not intended as a guide to general roof construction and examples given here have been created to demonstrate how the Envirotile system is fitted.

Note that this guide assumes the use of product supplied by Eurocell. Whilst some products can be replaced with generic branded products for the same application all product warranties are based on the installer fitting Eurocell branded products.

For Gable and Abutment wall roofs see pages 8 to 27



For Hipped roof see pages 28 to 38



5. SETTING UP

Prior to beginning the roof it is critical that the roof area that is to be covered with roof tiles is level and square before installation.

5.0

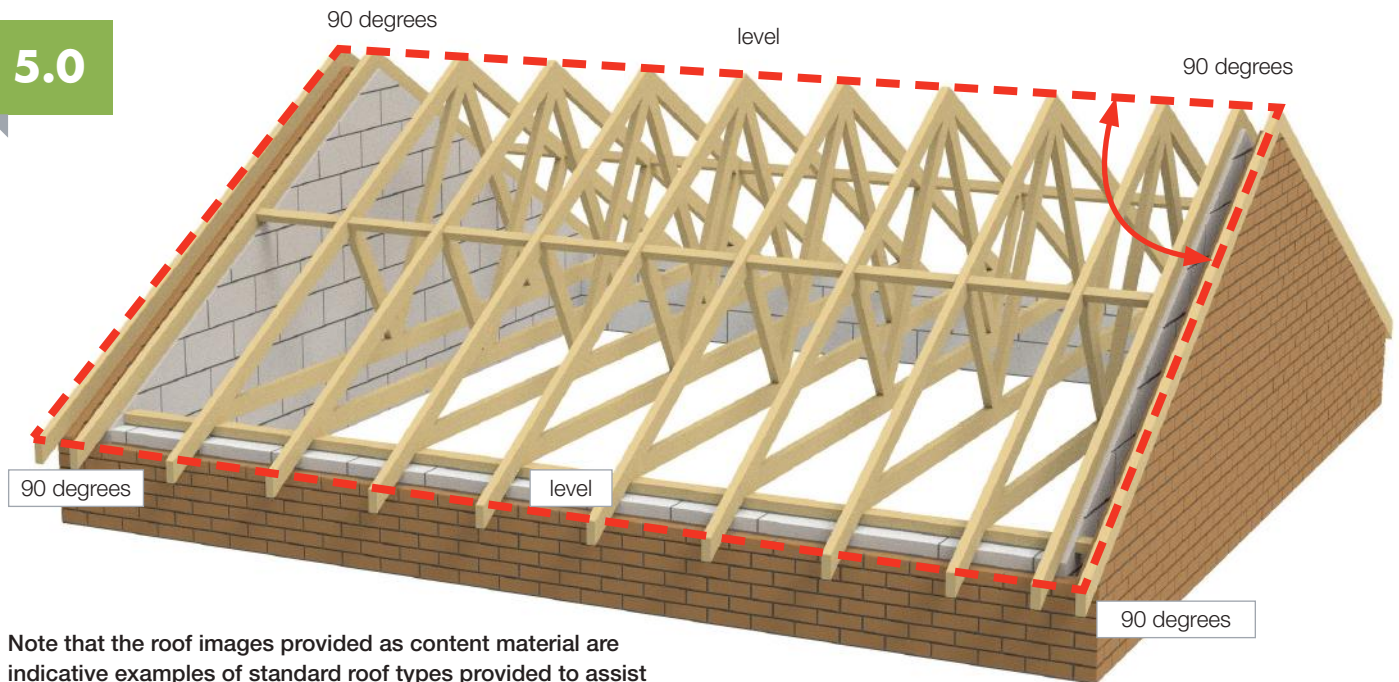

Note that the roof images provided as content material are indicative examples of standard roof types provided to assist the installer with a visual perspective of the different stages of the Envirotile installation process.

Always provide the correct ventilation requirements at the eaves soffit area.

Note: The roof pitch governs the recommendations of airflow per meter run required, on rafter pitches above 15 degrees it will require 10,000 mm/m of airflow per meter run and on pitches below 15 degrees 25,000mm of airflow per meter run is required for conformity to recommendations outlined in BS5250/2016.

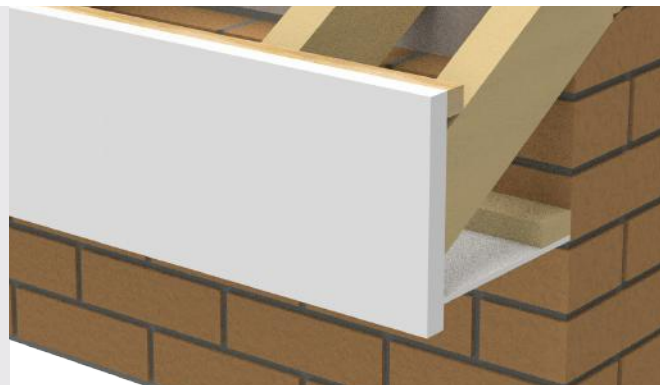

VENTILATION: FITTING THE CONTINUOUS ROLL OUT RAFTER EAVES VENT TRAY

By adding a continuous roll out rafter tray to your roof it will provide a clear ventilation path to the underside of the roofers underlay Envirolay (ENVIROLAY). Affix the roll over and between independent rafters along the whole width of the roof (as illustrated) position directly behind the ventilated fascia board area.

It is recommended that a minimum of 2 galvanised clout nails are used to permanently fix the continuous roll out rafter tray to each independent rafter.

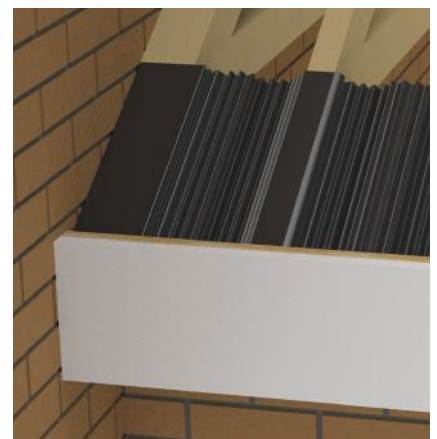
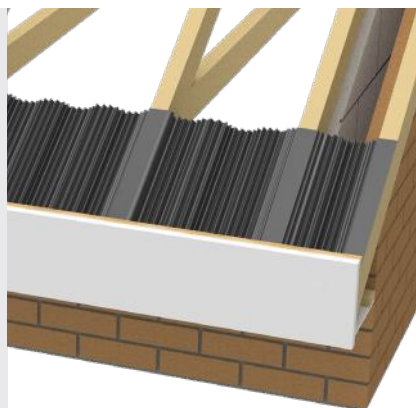

For abutment walls install the rafter roll out tray and fix to the end rafter

6. VENTILATION

6.0

SADDLE AND FIXING OF FELT SUPPORT TRAYS

Saddle the fascia board the full width of the roof with lengths of specifically designed Eurocell felt support trays. Align and affix to independent rafter centres using galvanised clout nails.

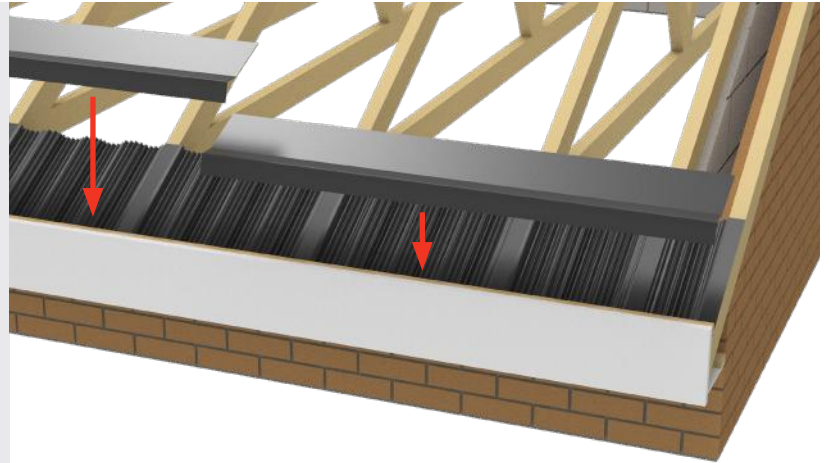

Note : At ends overlap each universal felt support tray by a minimum of 100mm to ensure water tightness is maintained.

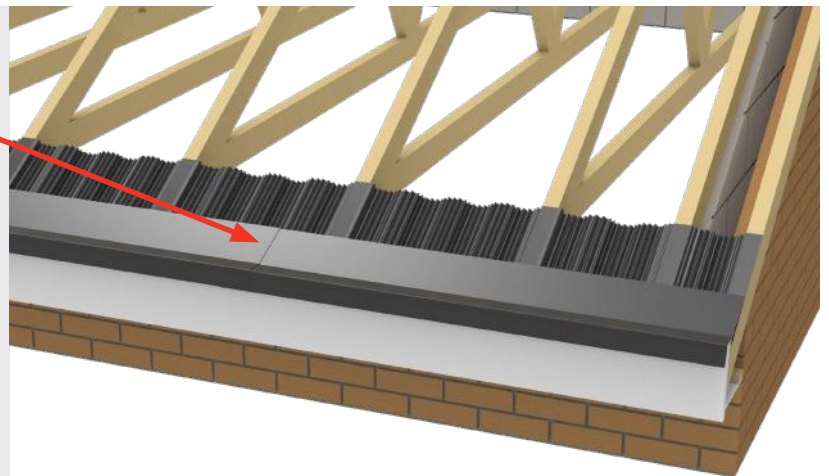

Butt up against the abutment wall with the felt support tray.

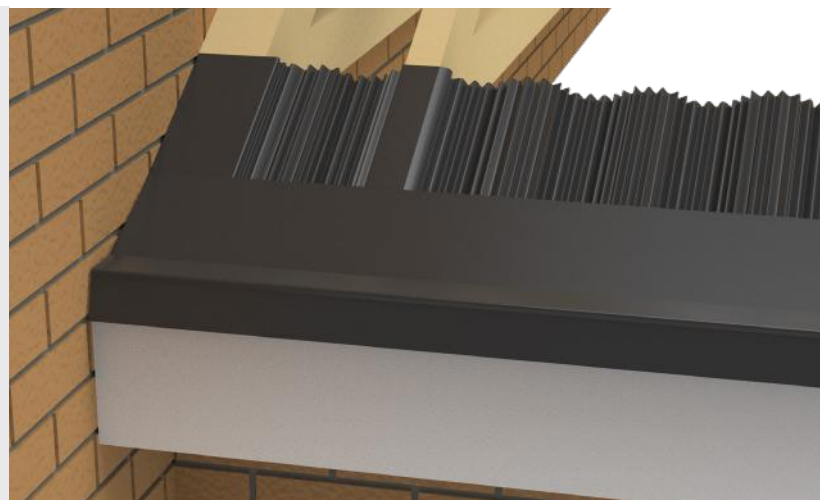

7. EAVES STARTER RAIL

7.0

MECHANICALLY DRY FIXING VENTILATED EAVES BAR/STARTER RAILS

Please note that the Eavebar/Starter Rail ENVEB is an integral part of the Envirotile Roof System and has been specifically designed to provide both the secure patented holding features for the first course of roof tiles as well as added ventilation to the underside of the roof covering which allows for built up condensation and moisture to escape through the viaduct channels.

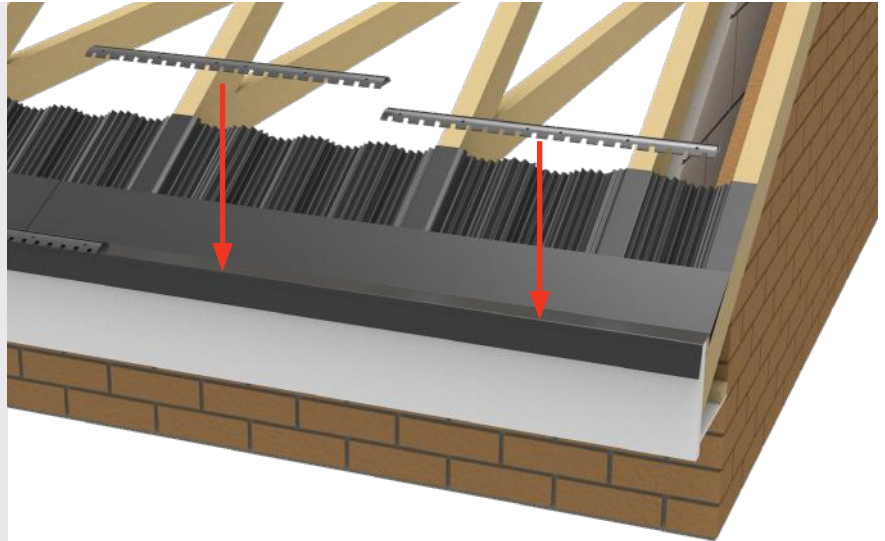

Starting at the right hand gable end verge, run through the full roof width with eaves bar/starter rails ENVEB then mechanically fix with stainless steel screws. Saddle the felt support tray before fixing permanently.

Note: Use the pronounced front edge lip located on the Eaves Starter rail and saddle the shaped contours of the felt support tray using the designated screw apertures to screw fix into the head of the fascia.

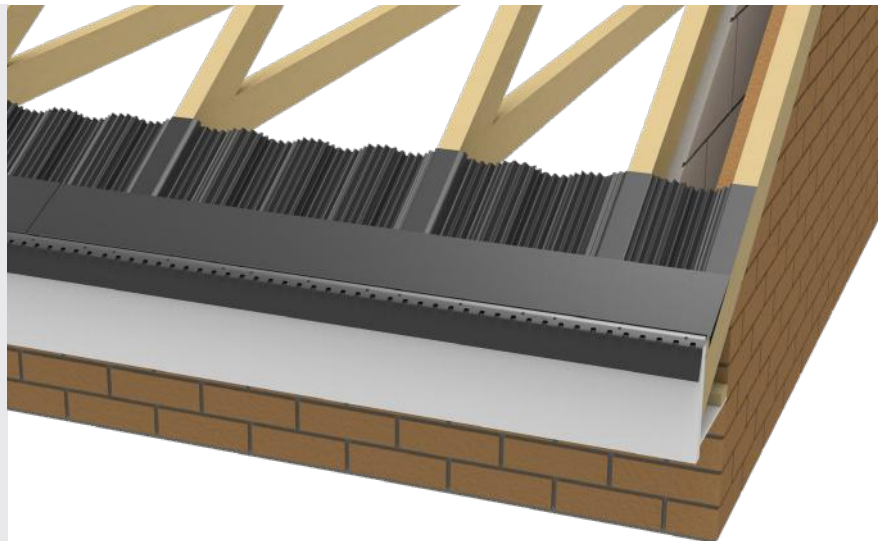

For abutment wall roofs ensure that the final Starter Rail located next to the wall provides a gap of 40mm away from the wall edge.

DO NOT FIT THE LAST STARTER RAIL AT THIS STAGE - REFER TO ABUTMENT WALL.



8. ENVIROLAY INSTALLATION

8.0

ENVIROLAY INSTALLATION PROCEDURE

Please note that only Envirolay (ENVIROLAY) is approved for full use with the Envirotile Roof System in conformity to Fire Standard BS:476-3. If another universal type of underlay is used for Envirotile installation on a cold roof type it will contravene Eurocell's guarantee and roof performance and all warranties will be considered null and void. Warm roof types are exempt and can, subject to design, use other types of underlay provided that the warm roof system is fully approved for full use in conformity with the latest revised and updated building regulations for 2020 onwards.



ENVIROLAY (ENVIROLAY)

Starting at the right hand gable end roll out and fix to the centre of rafters a single course of Envirolay (ENVIROLAY) to the full roof width to be battened; fixing and securing the roof underlay at rafter centres with clout nails as you go along. A 15mm sag/drop is required between rafters to allow for interstitial condensation to run down the roof below fixed battens. Overlap the eaves/felt support trays by a minimum distance of 100mm for the first course of underlay (illustrated).

Cut the underlay straight at gable ends with a sharp knife or robust pair of scissors in line with the gable end edge.

Always overlap each Envirolay course by a recommended minimum distance of 150mm.

Use Duo Plus tape (ENVTAPE) to seal the overlap layers to provide added protection against high wind uplift loads during full exposure.



DUO PLUS TAPE (ENVTAPE)

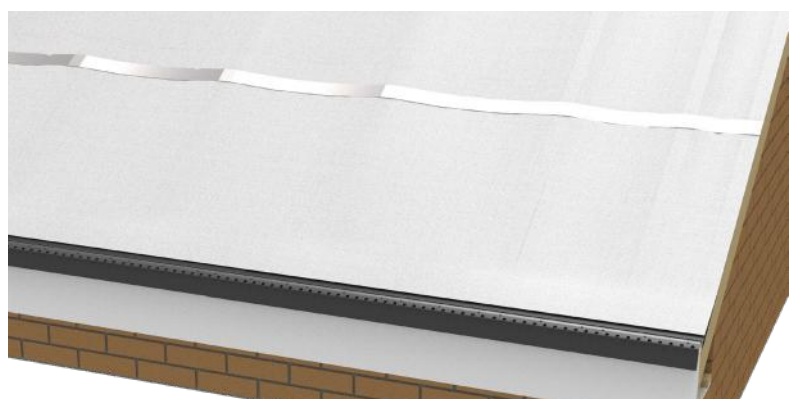
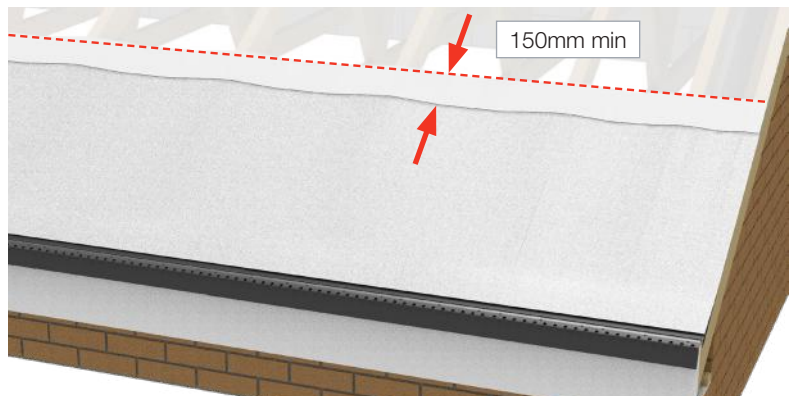
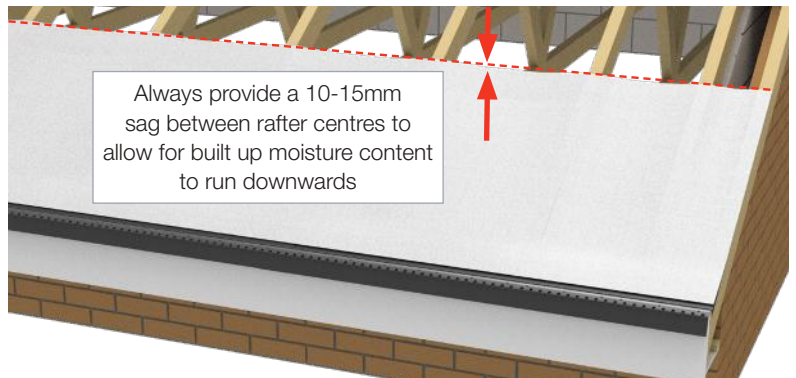
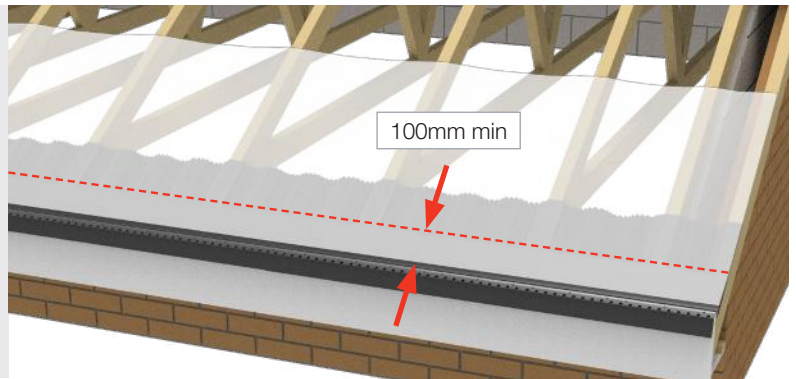

8. ENVIROLAY INSTALLATION

8.1

ENVIROLAY RIDGE DETAIL

Always leave a 25mm gap each side of the rafter ends at apex.

Note: The gap provided at apex will provide the area for rising interstitial moisture and condensation to escape through the ventilated Envirotile main roof ridge system.

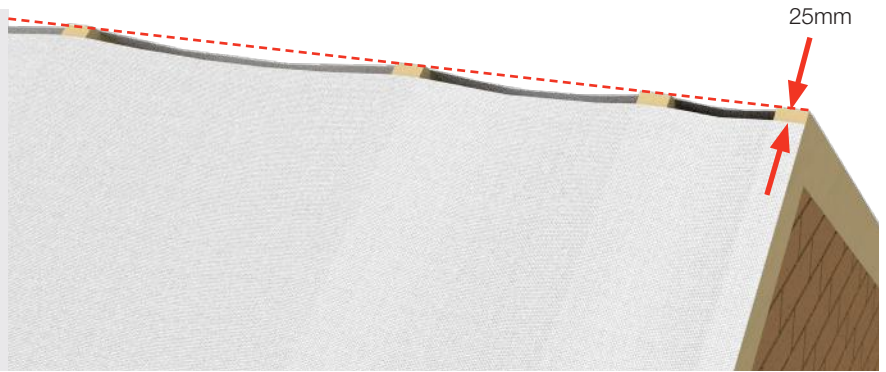

ENVIROLAY ABUTMENT WALL DETAIL

Run the Envirolay to the wall face and provide an uplift of material of at least 150mm. Use Duo Plus Tape ENVTAPE to seal the overlap layers.

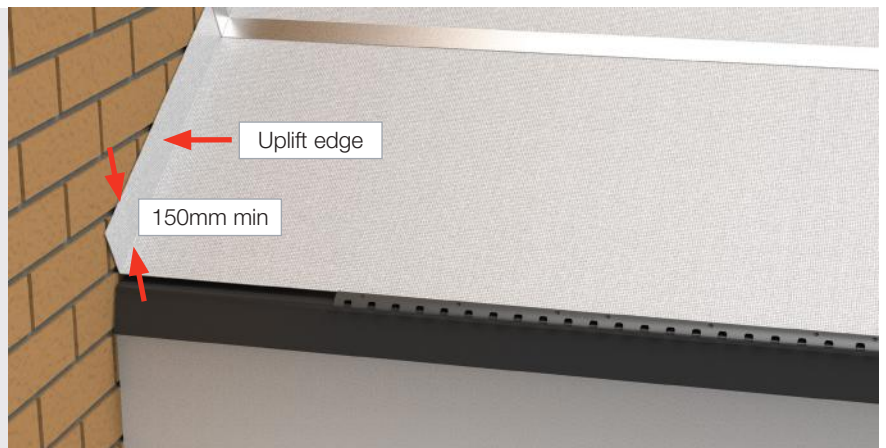

9. FITTING BATTENS

9.0

INSTALLING THE FIRST COURSE OF BATTEN

The Envirotile system relies upon the first course being an accurate gauge setting and bench mark for penultimate courses

Using a standard single Envirotile as (illustrated) will determine the location of the first bottom eaves batten.

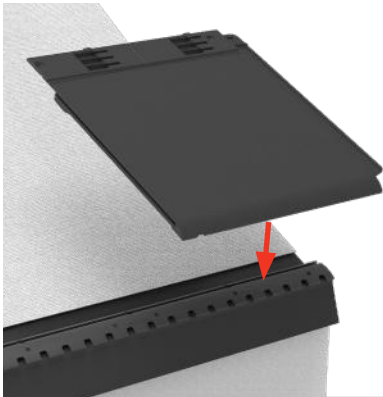

Take an Envirotile and push and clip the lower joining clip (E) into the eaves/starter rail as illustrated.

At the first gable end right hand rafter make a pencil mark at the top leading edge of the tile, as illustrated.

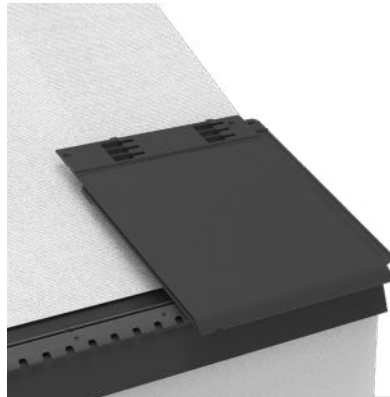

At the first rafter lay the tile flat onto the pitched rafter as illustrated.

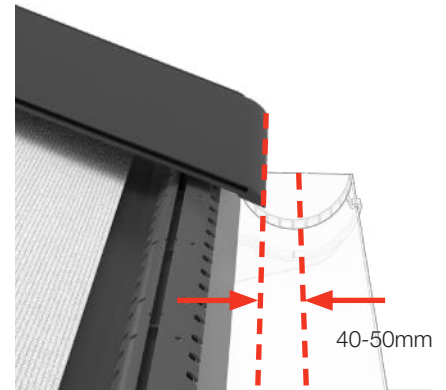

Note that the distance between the leading edge of the tile should be located approximately centre of the fixed gutter by a distance of 40-50mm

Repeat the process for the left hand edge, then provide a chalk line along the full width of the roof.

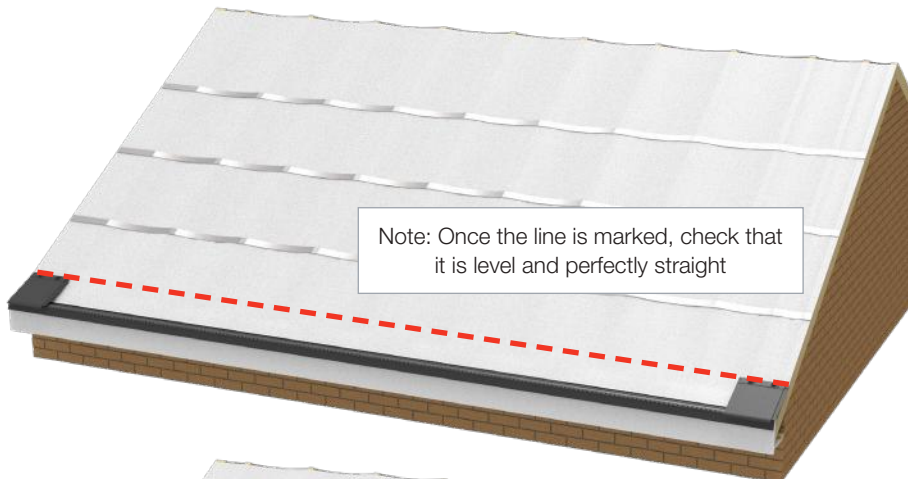
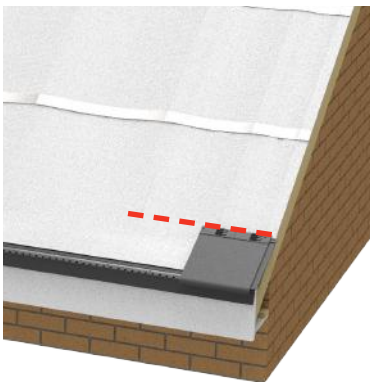

Fix the first course of battens using the marked line.

PLEASE NOTE: IT IS CRITICAL THAT THE FIRST BATTEN IS LEVEL!

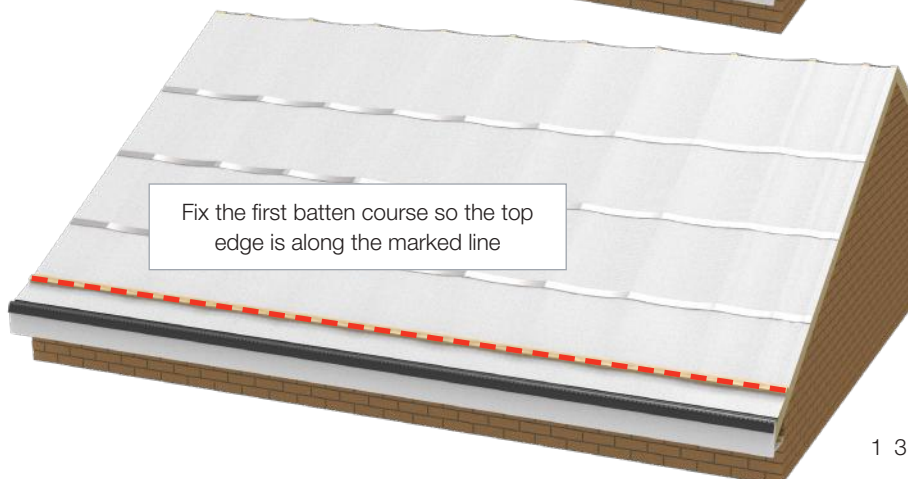

9. FITTING BATTENS

9.1

BATTEN SETTING OUT AND FIXING

Referring to the illustrations, measure the distance between the top apex final course batten (top edge) to the first bottom eaves course batten (top edge) and from that dimension deduct 35mm.

The result is the distance between the top batten and the first course of batten using the top edges to measure from.

Use this distance to calculate the number and spacing of battens, being careful to note the minimum batten gauge required (see below).

N.B Always use a chalk line to establish the gauge for each batten course, the top edge of the batten is mechanically fixed to the underside of the chalk line.

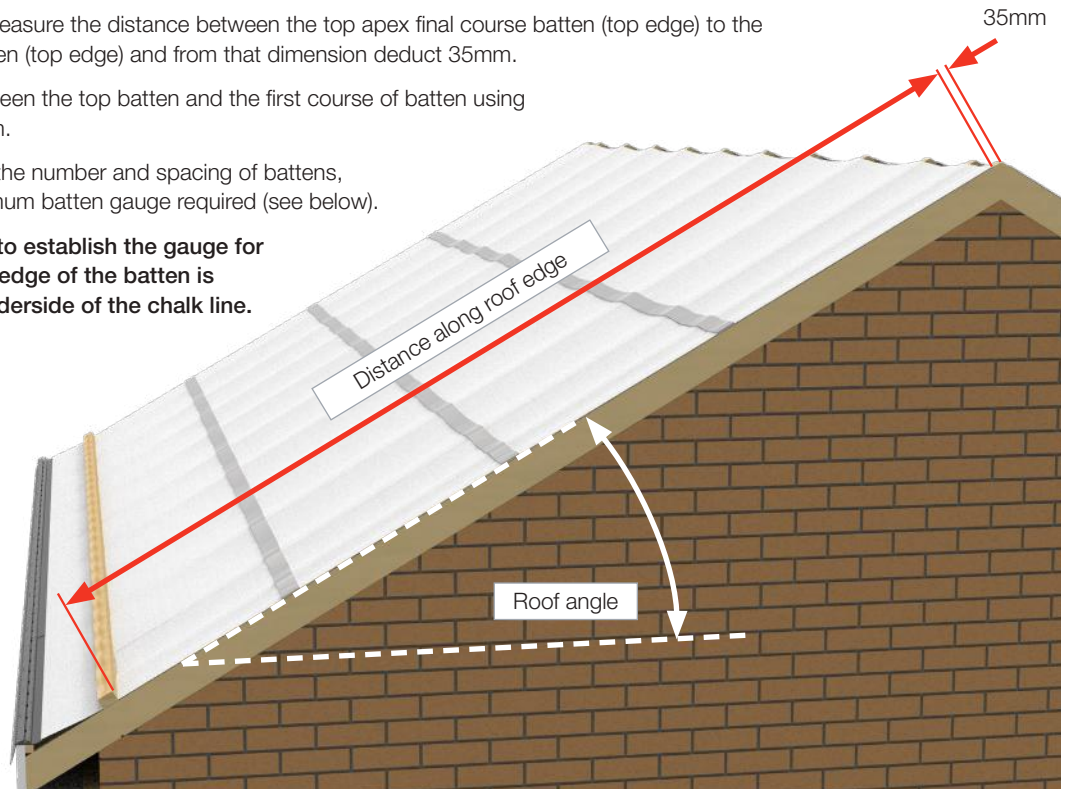

Fix the battens, leaving out the final top course.

Note: The installer may need to adjust the batten gauge settings to accommodate the rafter dimensions. This is achieved by reducing the gauge to either a 265mm or 250mm gauge setting to assist the final position of the top course of batten. Alternatively, set out the battens to your preferred gauge and affix a short final batten course where the installer will have to simply cut and shorten the top course of tiles as illustrated on page 18.

Where roof angle is below 22.5° the batten/tile gauge setting required is 250mm.

Where roof angle is over 22.5° the batten/tile gauge setting can be 250, 265 or 280mm depending on the installation.

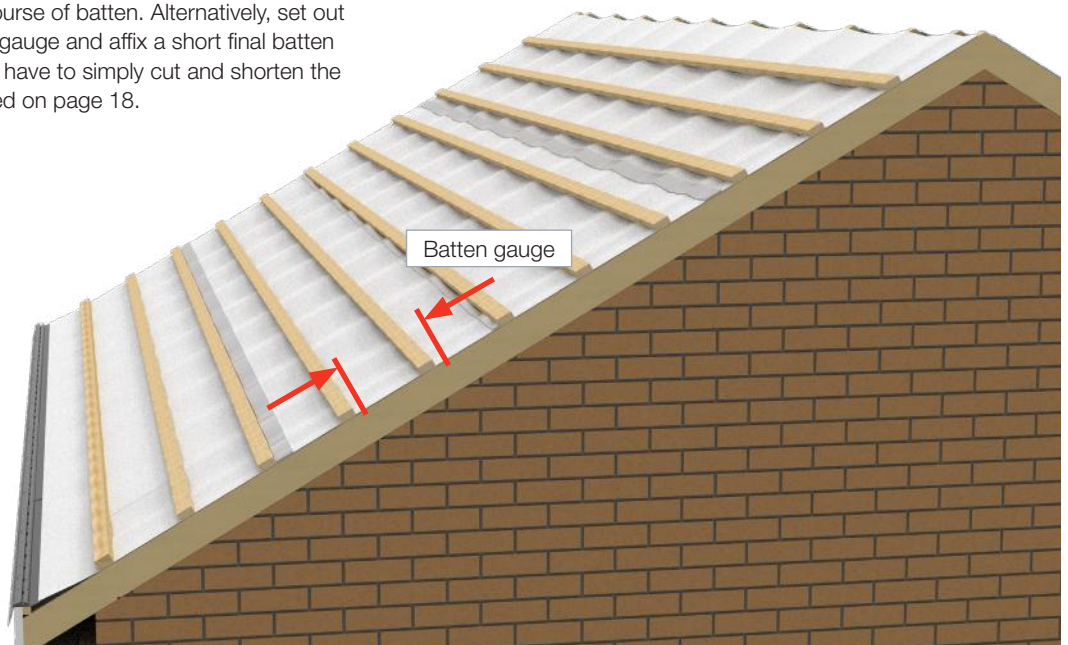

9. FITTING BATTENS

9.2

RIDGE STRUCTURE

Before the last top eaves course batten is fixed, fix a 50mm x 50mm bedded batten above the rafters using rafter straps (non-supplied).

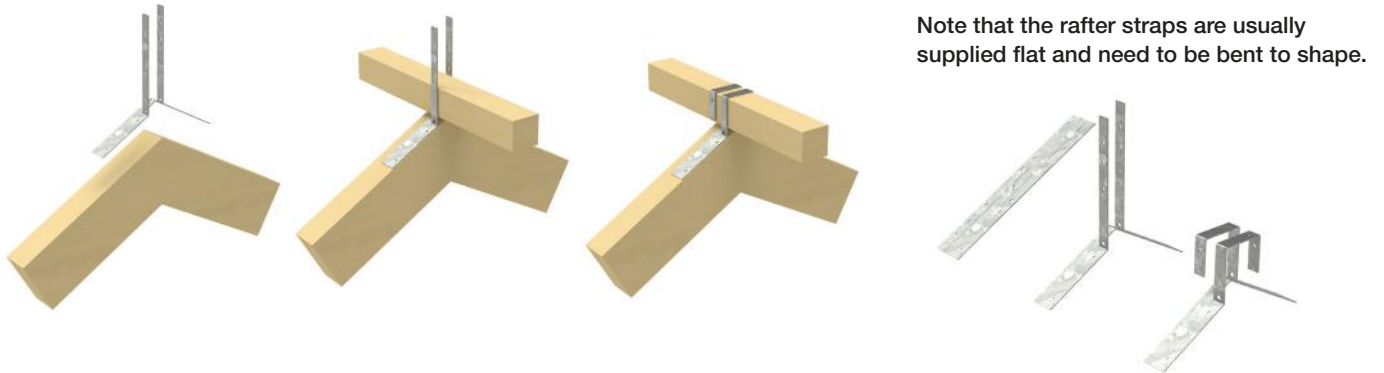

Fix the apex batten to the rafters as shown above



Then fix the top batten course, 35mm down from the rafter apex

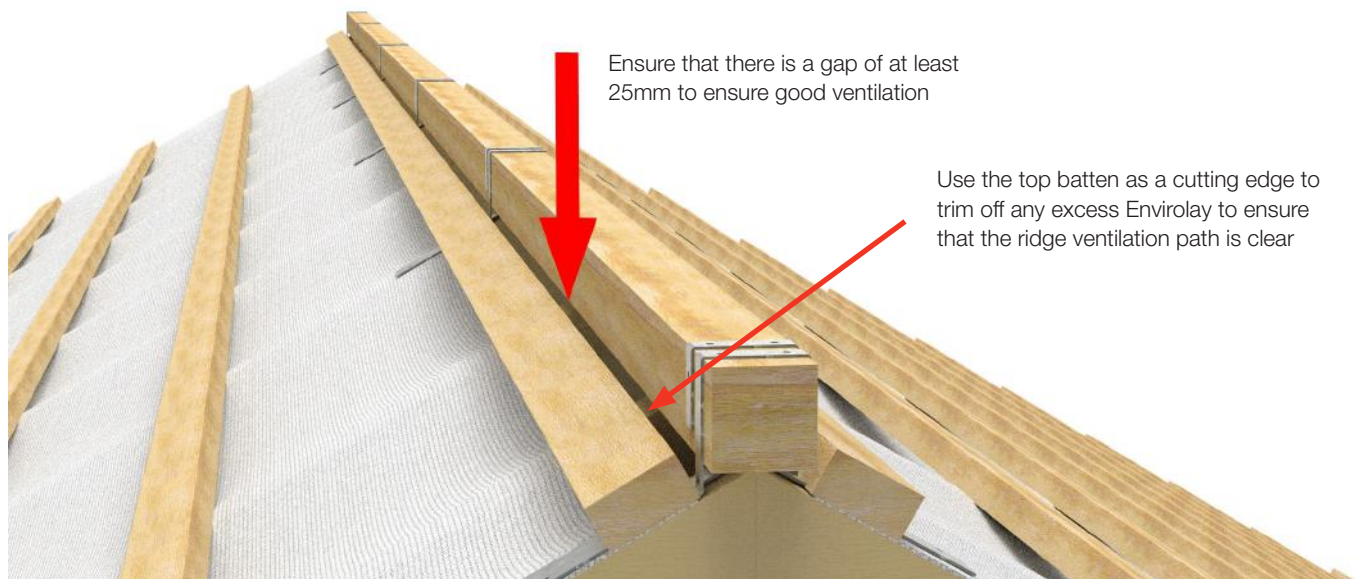
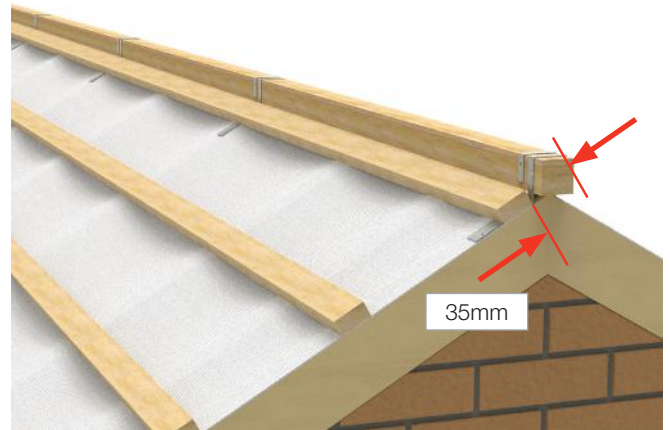

9. FITTING BATTENS

9.3

ALTERNATIVE TOP BATTEN SETTING OUT

Envirotiles can be cut with a hand saw very easily so an alternative option for the batten setting out is to set out the battens up the roof face by the recommended gauge (see page 16) then fit the top batten course so that the gauge is different. For the top row of tiles the installer can then cut off the TOP EDGE of the tile so that it clips into the lower tile and lines up with the top batten edge.

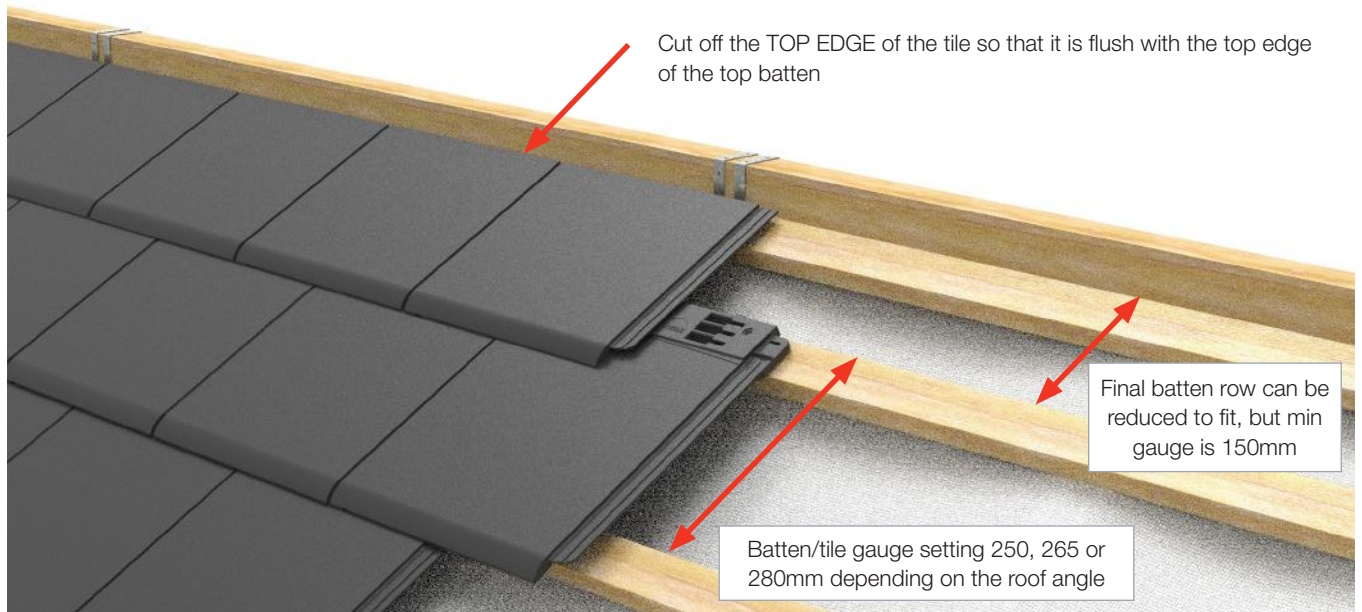

ABUTMENT WALL BATTEN DETAILS

At abutment walls fit battens so that there is an 80mm minimum clearance between the batten and the wall face.

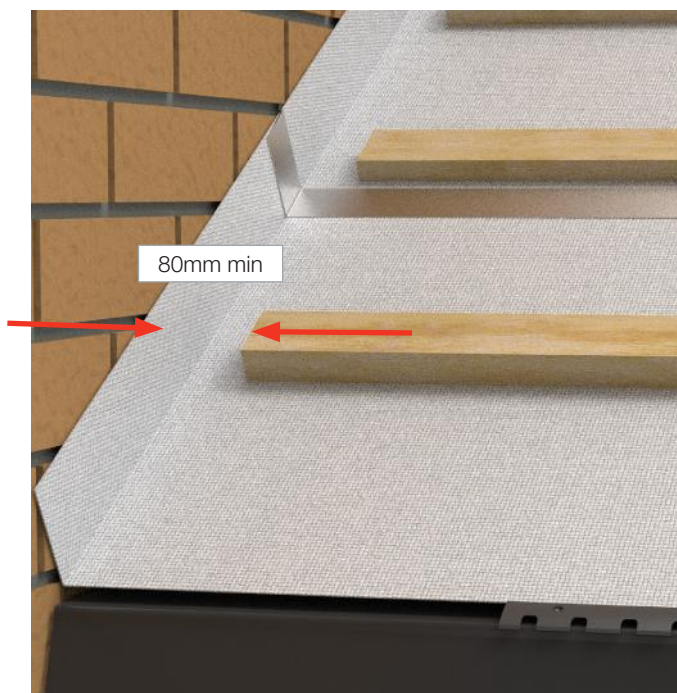

ABUTMENT WALL RIDGE STRUCTURE DETAIL

Allow 80mm clearance at the ridge batten.

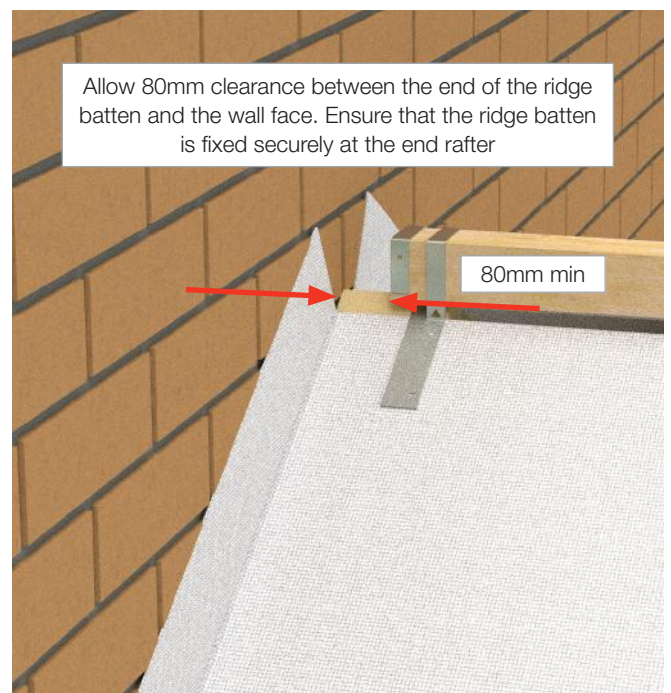

10. DRY VERGE INSTALLATION

10

INSTALLING THE CONTINUOUS DRY VERGE



To finish gable ends it is recommended that the continuous dry fix verge (ENV3MDV) is used. This is fitted over the top of the battens and runs along the top edge of the end rafters at gable ends. Use dry verge brackets (ENVDVB) to join lengths of dry verge if required.

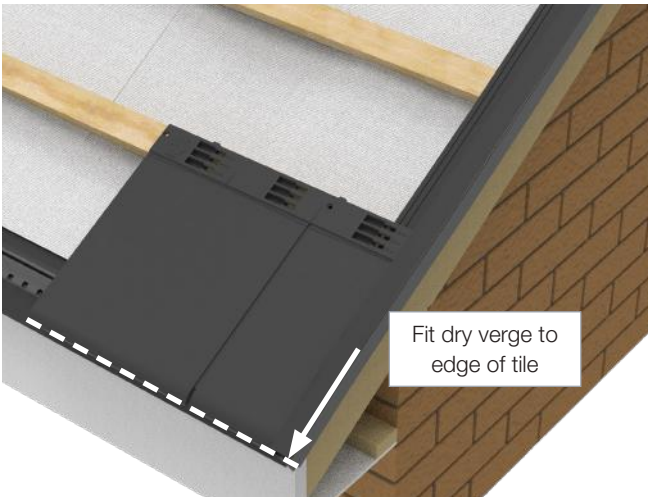

At the gable ends slide a roof tile (first roof tile) into the eaves/starter rail at the gable end as shown.

Simply position the end of the continuous dry verge unit directly in line and flush with the bottom edge of the overhanging roof tile and place the inner sleeve directly onto the exposed batten ends that have been cut flush with the gable roof edge.

Fix with 30mm stainless steel screws downwards into the top of the battens making sure the dry verge unit is perfectly in line with the verge.

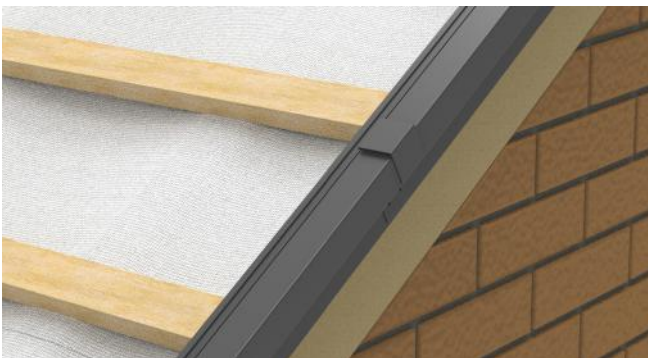

Fix a bracket clip, if required, with screw fixings ENVDVB, to join lengths of continuous dry fix verge when rafters are longer than 3m in length.

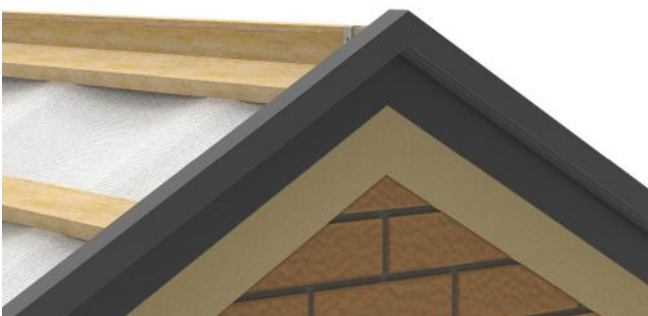

At the apex centre mitre cut and abut to the continuous dry verge unit to the correct pitch angle in readiness for the gable end cap to be fixed.

Note: It is recommended that fascia board is used to envelope/overlap the continuous dry verge at exposed gable ends. This provides improved aesthetics as well as additional protection against severe wind uplift.

11. INSTALLING THE ENVIROTILES

11

INSTALLING THE ROOF TILES - KEY POINTS

Envirotiles are very easy to install, but it will help to familiarise yourself with the important design features of the tile to ensure that you understand how the tiles fix together.

Envirotiles are laid using the standard 3 step layout procedure. This is detailed on page 22.



Always lay tiles in half bond.

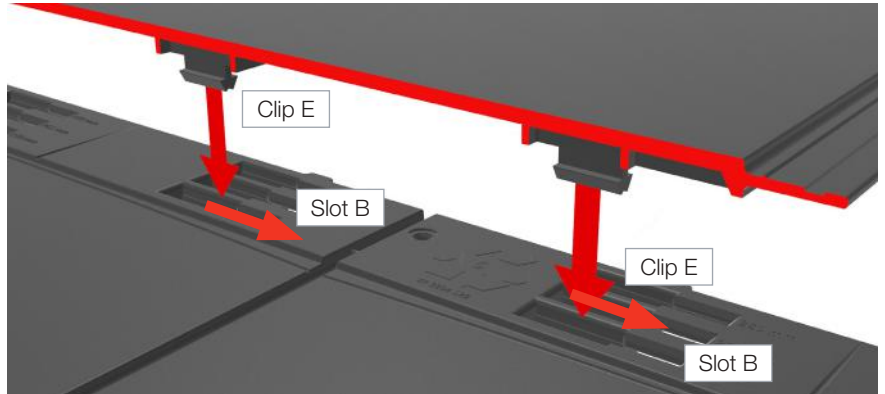

Envirotiles are clipped together using the two clips on the underside at the bottom of the tile (E) clipping into the slots at the top of the tile on the course below (B). Note that the tile must be aligned, then pushed down, then the tile is slid to the right to lock into the clip. The sliding action also locks the connecting strip into the adjacent tile slot.



Ensure that you clip the tiles into the right slots depending on the batten gauge used.

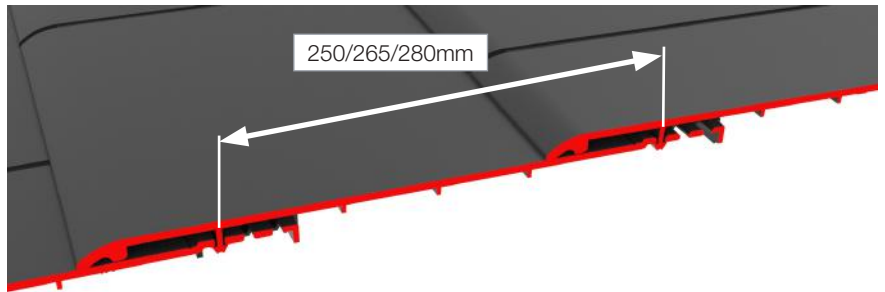

Detachable nib F

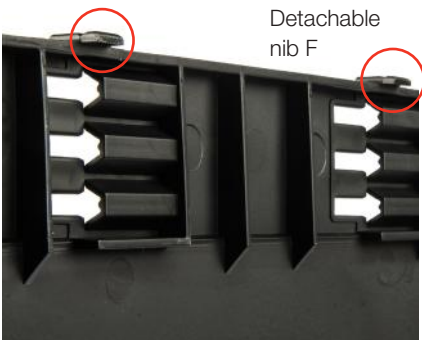

Each tile has two detachable nibs (F) at the top. These are used to hook the tile over the batten. When a batten has been fitted out of alignment or there has been some movement after fitting, the installer can break the nibs off as required if they find that the nibs no longer hook over the batten.

11. INSTALLING THE ENVIROTILES

11.1

BEFORE YOU START

Prior to commencement of roof tile installation mark out with a pencil where the tile pack rows are to be conveniently and evenly placed and spaced.

Provide enough room between the rows of stacked, packed tiles to be able to work freely and without hindrance.

Only load enough packs of tiles to the roof area that the installer feels will be used during the period of tile fixing/installation.

Unused packs of tiles should not be left on exposed roof areas overnight or for any long period as a preventive measure against damage/injury caused by wind loads.

A single pack of single roof tiles covers an approximate area of 0.8m²

Note: During and after the tile installation remove and regularly collect all loose pack strapping and place away from the roof working area as a preventive trip hazard.



IMPORTANT FEATURES

Always lay the roof system to half bond.



Always provide a 5mm gap between tiles to accommodate expansion/contraction.

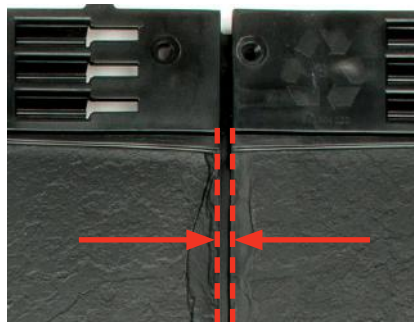

Note: An embossed 5mm marker/guide line is etched onto the tile interlocking insert fin to assist the installer with spacing.



The roof tiles incorporate design features that maintain straight plumb lines to ensure straight vertical bonding.

Each roof tile has an embossed centre mark line located at the head of each roof tile this mark provides the correct positioning for the purpose of cutting half tiles.



Tiles can be cut with a hand saw

Each roof tile is designed to be permanently fixed and secured in place with neighbouring roof tiles and onto batten at 8 separate points.

One 32mm x 4.2mm Stainless Steel Pozi Pan Self Tapping (ENVSCREW32) or driven nail required to fix a single tile. On gable ends or abutment walls 2 fixings are required per tile.

Tiles can be freely traversed when secured and installed permanently onto roof areas.



11. INSTALLING THE ENVIROTILES

11.2

INSTALLING ROOF TILES ONTO THE EAVES BATTEN

Starting from right to left without fixing, run through the full length of the first eaves/course with tiles to ascertain the correct location and permanent fixture position of the first course of tiles.



Take the first tile and cut off the right hand connecting strip using a hand saw - see above.



Use a full tile to start and cut off the right hand connecting strip.

Next, clip this cut tile into the starter rail, as shown, and rest the top over the batten - using the lugs as guides to hook on.

Then, slide this tile into the dry verge as shown.

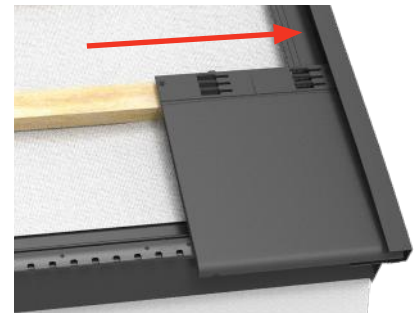
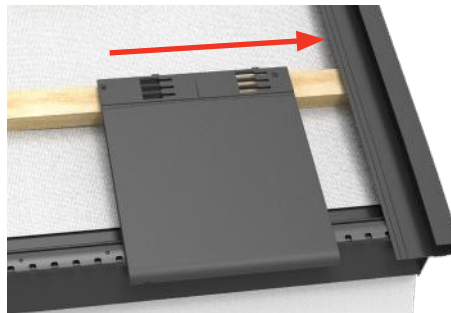

Take a new tile and clip into the starter rail, hook over the batten, then slide this tile into the end tile so that the connecting strip fits into the left hand slot of the tile. Push together ensuring there is a 5mm space between the top faces of the tiles.

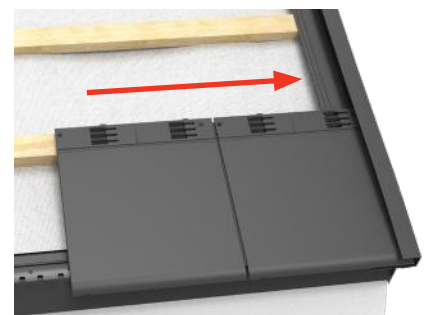
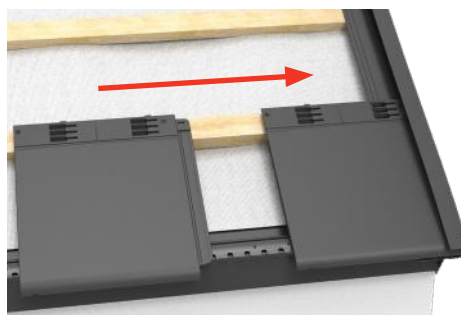

The spacing between tiles can be adjusted to allow for course length (see next stage), but ensure that the minimum spacing is 5mm, and that the fixing hole (A) comes over slot (B) when the tiles are joined.

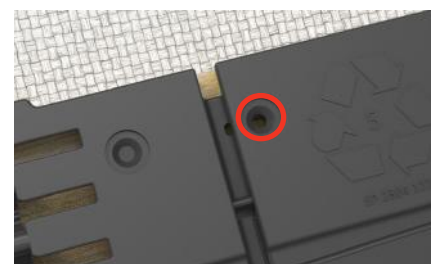
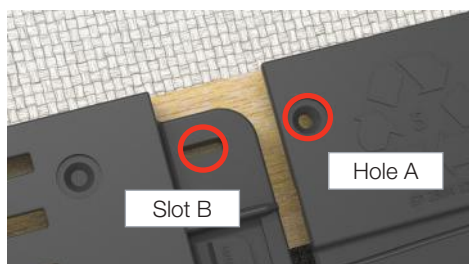

11. INSTALLING THE ENVIROTILES

11.3

INSTALLING THE FIRST EAVES COURSE OF TILES

Continue to fit tiles on the first eaves course as shown until the full row is complete.

At the left hand side ensure that you have at least a half single tile to fix.

Note that the tiles can be cut with a hand saw and there is a centre mark moulded into the tile to help.

If the tile spacing is such that less than a half tile remains you can either adjust the tile spacing along the course to increase the end tile size, or you can replace a single tile with a double tile along the course and/or at the end, so that the end tile is larger than a half single tile.

Note:

Envirotile single and double sized tiles are interchangeable and can be used at gable ends if required. The double tiles are ideal for infilling large runs quickly and for use when cutting around rooflights, dormers, chimneys, etc.

When the first row of tiles has been fitted and spacings adjusted securely fix down the tiles using the fixing points D and J. Note that in the run, the left hand fixing D will secure the adjacent tile on the left hand side through slot J (see previous page).

Always use 2 top fixings (D and K) for full gable end tiles. At the gable ends if a fixing point is missing on the left hand or right hand side, due to a cut tile, drill a hole through the tile and fix through to the batten.

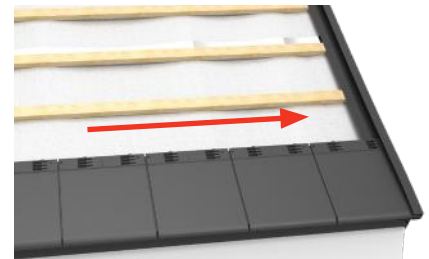
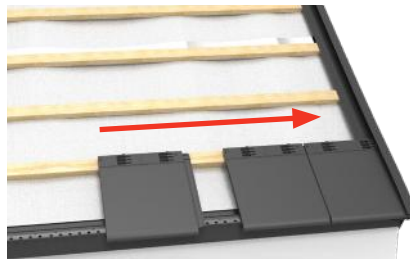

Envirotile Single Tile

Envirotile Double Tile

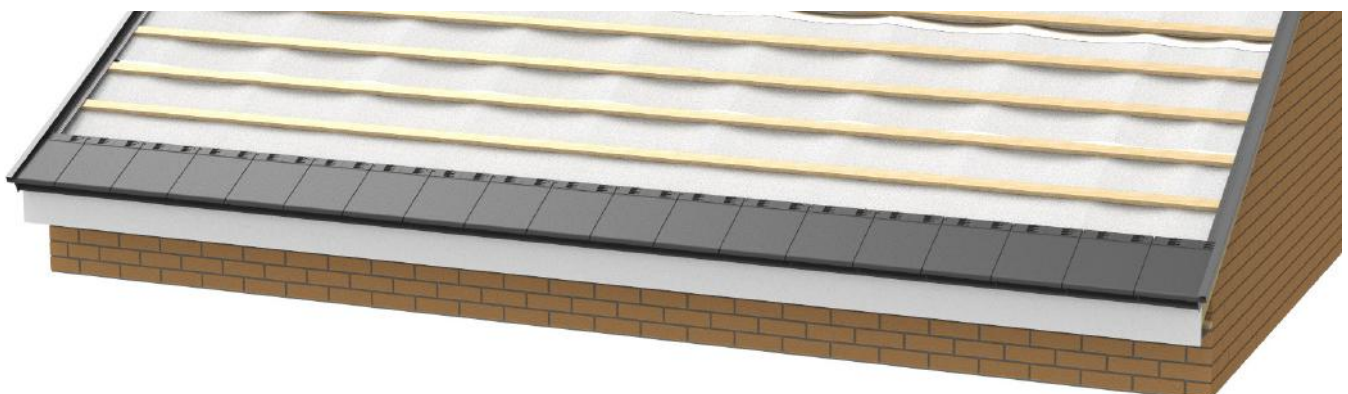

11. INSTALLING THE ENVIROTILES

11.4

INSTALLING THE ROOF TILES

Envirotiles are laid using the standard 3 step layout procedure.

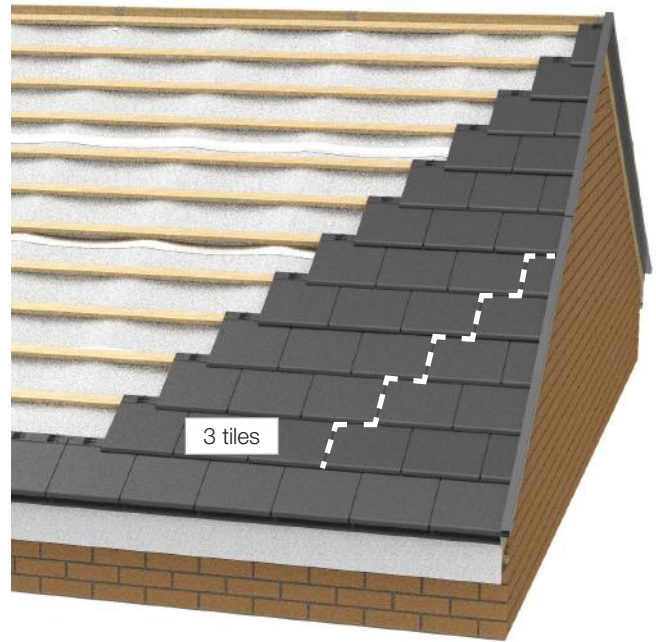
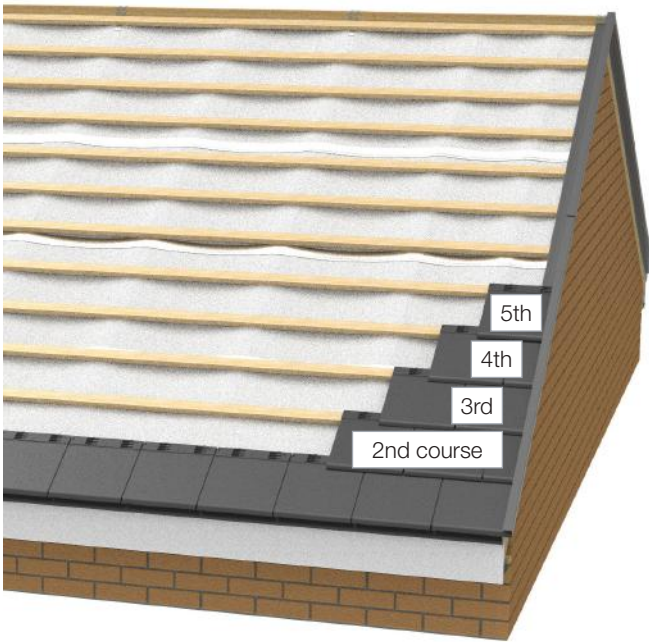

- 1) Start the 3 step tile procedure - 2nd course with a half tile and 2 full tiles
- 2) Start the 3rd course with 2 full tiles
- 3) Start the 4th course with a half and full tile
- 4) Start the 5th course with a full tile

Go back to the 2nd course and run through with 3 tiles only and repeat each course above using the same sequence as before. Continue this procedure until the installer reaches the top course of batten at the apex.

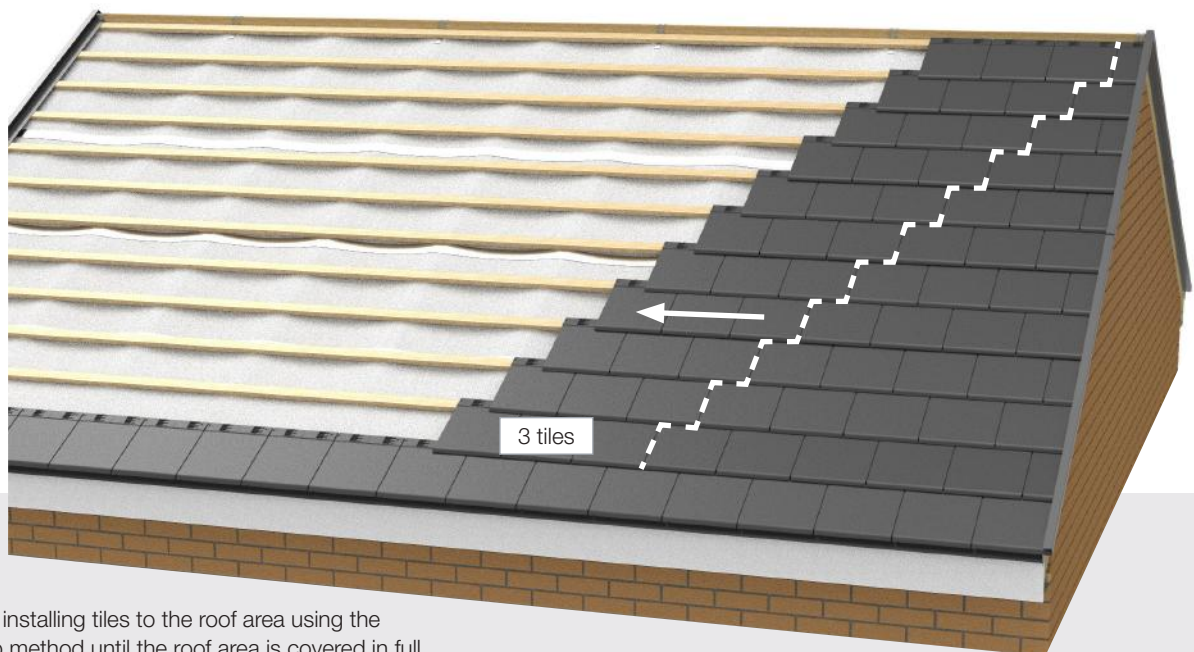

Continue installing tiles to the roof area using the 3 tile step method until the roof area is covered in full.

12. ABUTMENT WALLS

12

INSTALLING A UNIVERSAL ABUTMENT SOAKER

Lay the abutment soaker tight against the wall face (as illustrated) positioned above the felt support tray and then permanently fix to the batten edge. Ensure that the abutment soaker overhangs the fascia by the same distance as the eaves course roof tile.



When the abutment soaker is secured, fit the final starter rail as shown, screwing through the abutment soaker.

Ensure that the edge of the eaves/bar starter rail aligns with the edge of the abutment soaker channel.

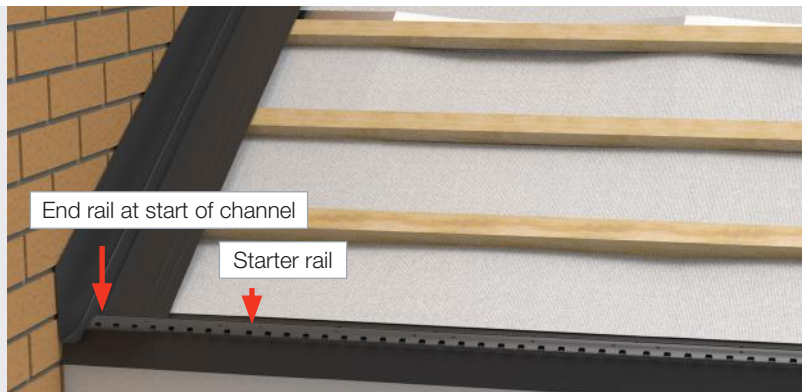

At the ridge apex, mitre the soaker as illustrated.

Note: If more than 1 length of abutment soaker is required, ensure that the 2 sections overlap each other by a distance of at least 150mm.



After fixing the abutment soaker correctly overlap/install the wall flashing to make watertight, as illustrated.



12. ABUTMENT WALLS

12.1

INSTALLING TILES AT ABUTMENT WALLS

At the abutment wall the end roof tiles must be screwed down/secured to the batten in 2 separate places using the 2 fixing points provided.

We recommend use of double tiles for cutting if required.



Leave a gap of 38mm between the abutment wall edge and end of roof tiles.

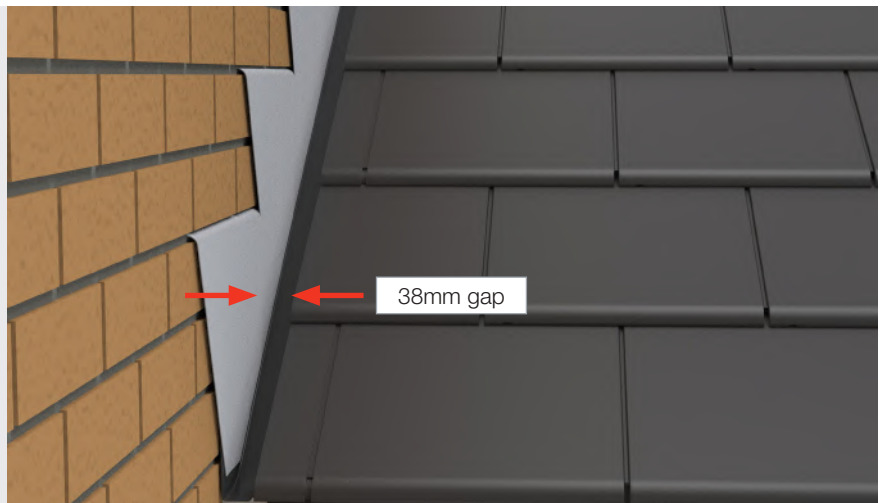

The 38mm gap between the parapet wall and roof tile edge provides the installer with enough room to engage the patented interlocking features into the surround tiles.

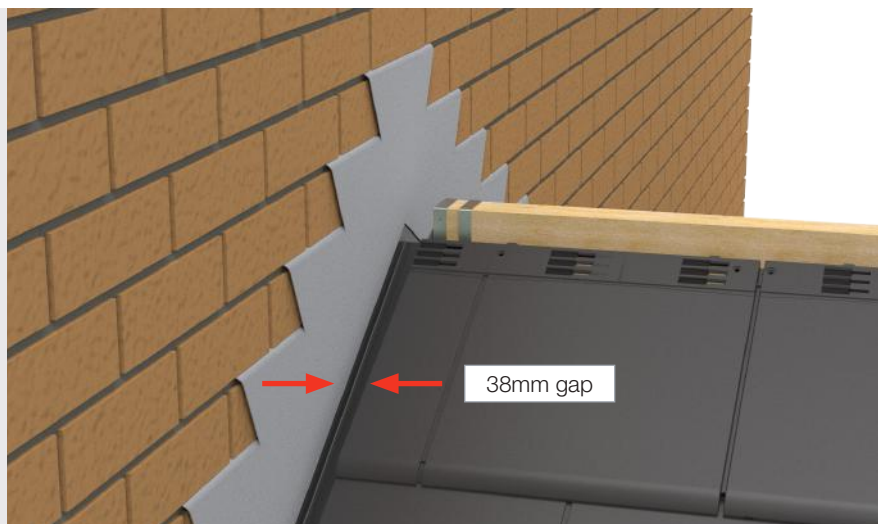

13. INSTALLING THE RIDGE

13

INSTALLING THE VENTILATED RIDGE ROLL

With all the roof tiles installed and securely fixed, the next step is to fit the ventilated ridge roll (ENV330RIDGEROLL).



VENTILATED RIDGE ROLL -
ENV330RIDGEROLL

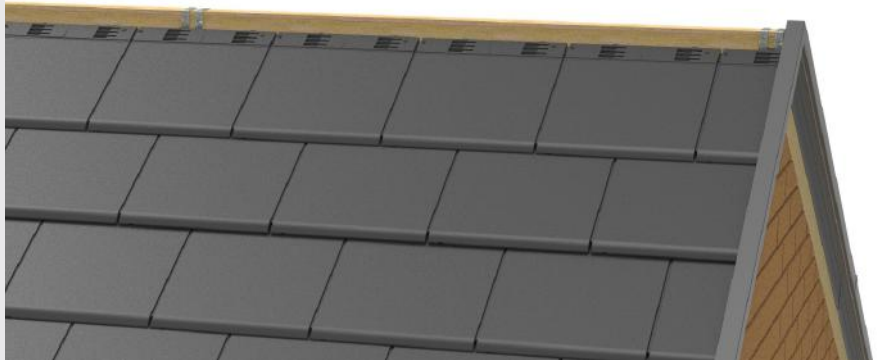

Place the ridge roll over the centre of the bedded batten and lay over the ridge apex ensuring the roof tiles are used as a substrate and overlapped by a minimum distance of 100mm either side of the apex.

When the ridge roll is correctly placed into position, remove the tape protection strip to permanently bond to the top eaves course tile surface preventing water ingress.

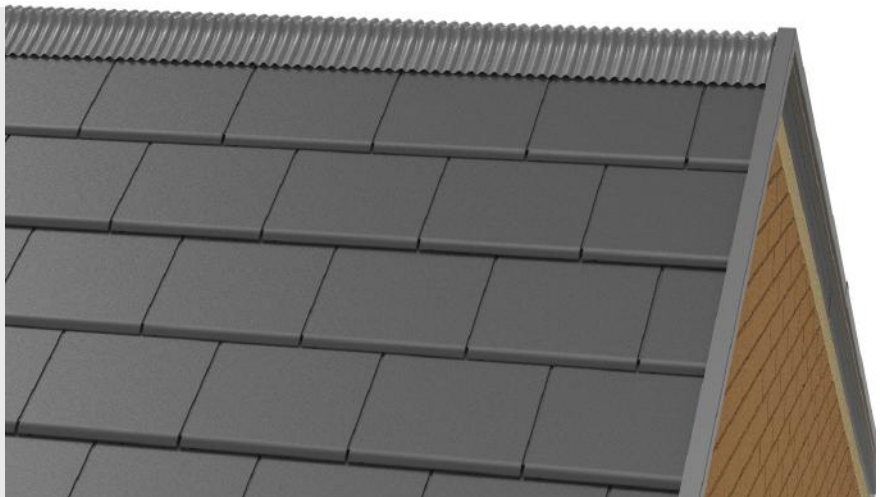

Run the ridge roll so that it butts up flush with the abutment wall ensuring an overlap at the top edge of the soaker channel.

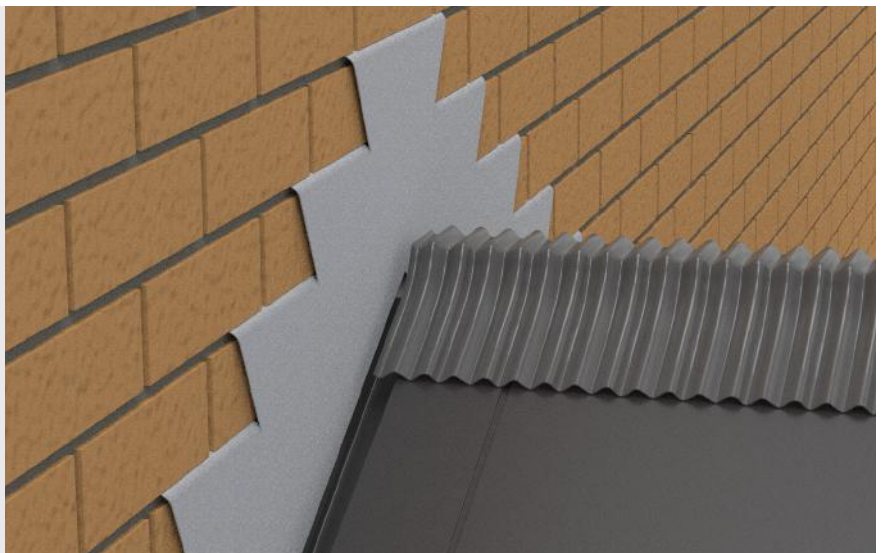

13. INSTALLING THE RIDGE

13.1

INSTALLING THE RIDGE PRODUCTS

Eurocell supply the dedicated ventilated full ridge system.

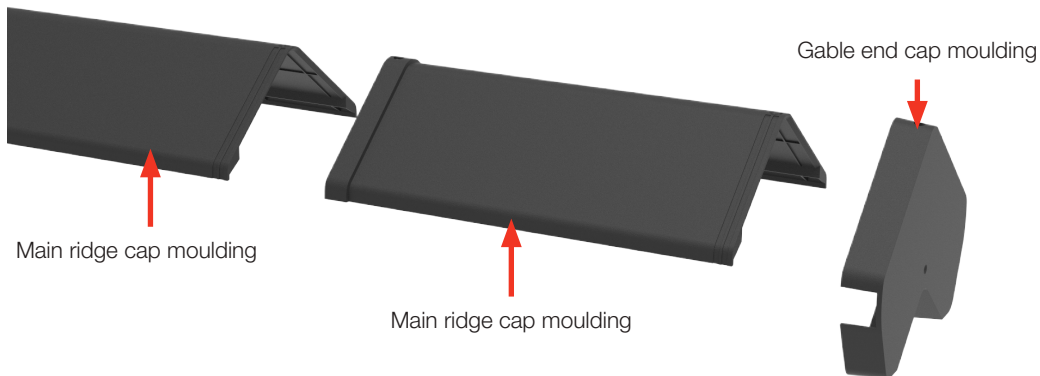

Starting at the right hand side of the roof, align and loosely fit the ridge cap mouldings over the ventilated ridge roll by interlocking the ridge sections together. At the gable the end cap envelopes the mitred dry verge before interlocking with the end ridge section (see illustration).

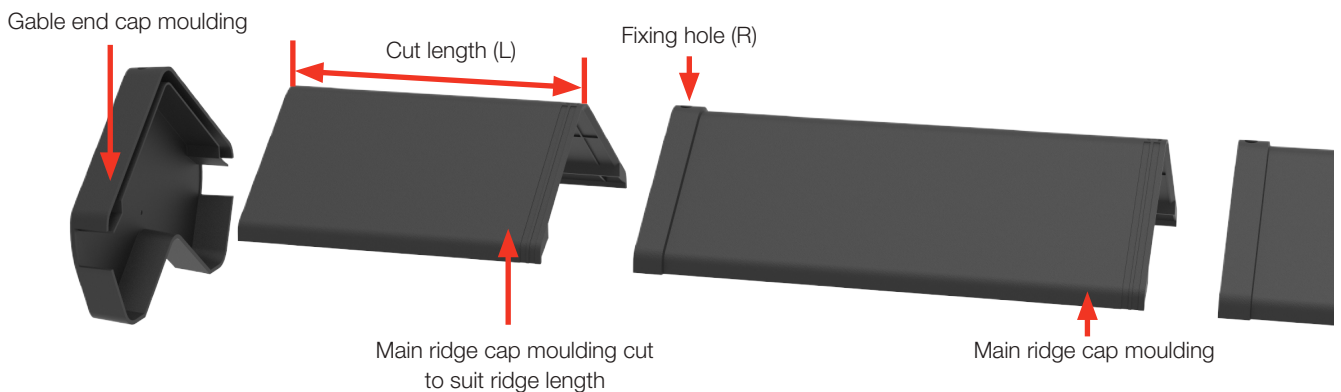

Lay out and interlock the main ridge sections together loosely along the full width of the roof. When correctly aligned permanently fix into place using the bedded batten as a fixture point for the 90mm x 6.3mm Stainless Steel Pozi Pan Self Tapping (ENVSCREW90) required to permanently fix two ridge sections together. Start the mechanical screw fixing procedure from the right hand gable end, using the fixing hole (R) on the apex at each end.

If the cut length (L) is less than half the length of the ridge cap moulding it is recommended that you cut two ridge cap mouldings and space accordingly.

Now cut the left hand ridge cap moulding to length, fit and secure.

At a gable end fit the left hand gable end cap moulding. At an abutment wall cut the ridge cap moulding so there is a 2-3mm gap between the flashing and the cut edge of the cap.

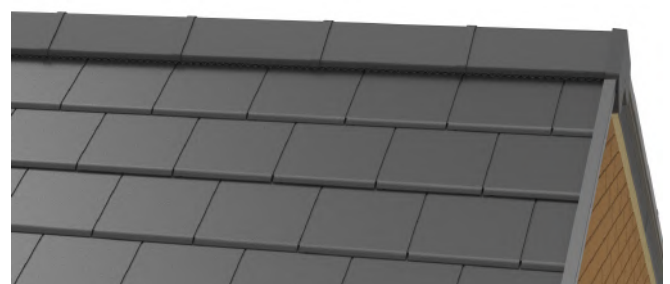

14. FINAL STAGES

14

FITTING THE GABLE ENDS FASCIA BOARDS AND GUTTERS

With all tiles installed and secure, the gutters, downpipes and gable end fascia boards can be installed (note that it may be beneficial to fit the gable end fascia boards before other stages, depending on the material used).



15. INSTALLING HIP ROOFS

15

SETTING UP

Prior to commencing the roof it is critical that the roof area that is to be covered with roof tiles is level (at the eaves and ridge) and square to any wall.

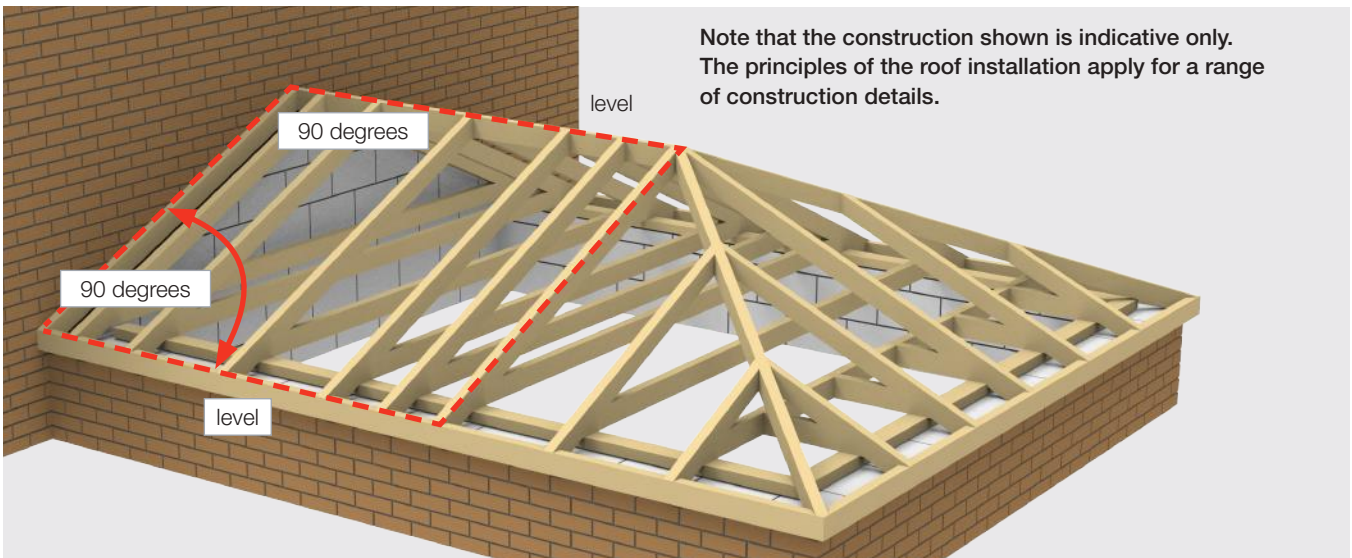

Provide the correct ventilation requirements at the eaves soffit area. If in doubt please refer to NCB specification.

Note: The roof pitch governs the recommendations of airflow per metre run required. On rafter pitches above 15 degrees it will require 10,000 mm/m of airflow per metre run and on pitches below 15 degrees 25,000mm of airflow per metre run, for conformity to recommendations outlined in BS5250/2016.

Add ridge beam and hip 50mm x 50mm battens to existing frame to act as screw fixing beds. Use galvanised steel brackets or similar to fix ridge and hip battens.

Fix fascia board to perimeter frame beam.

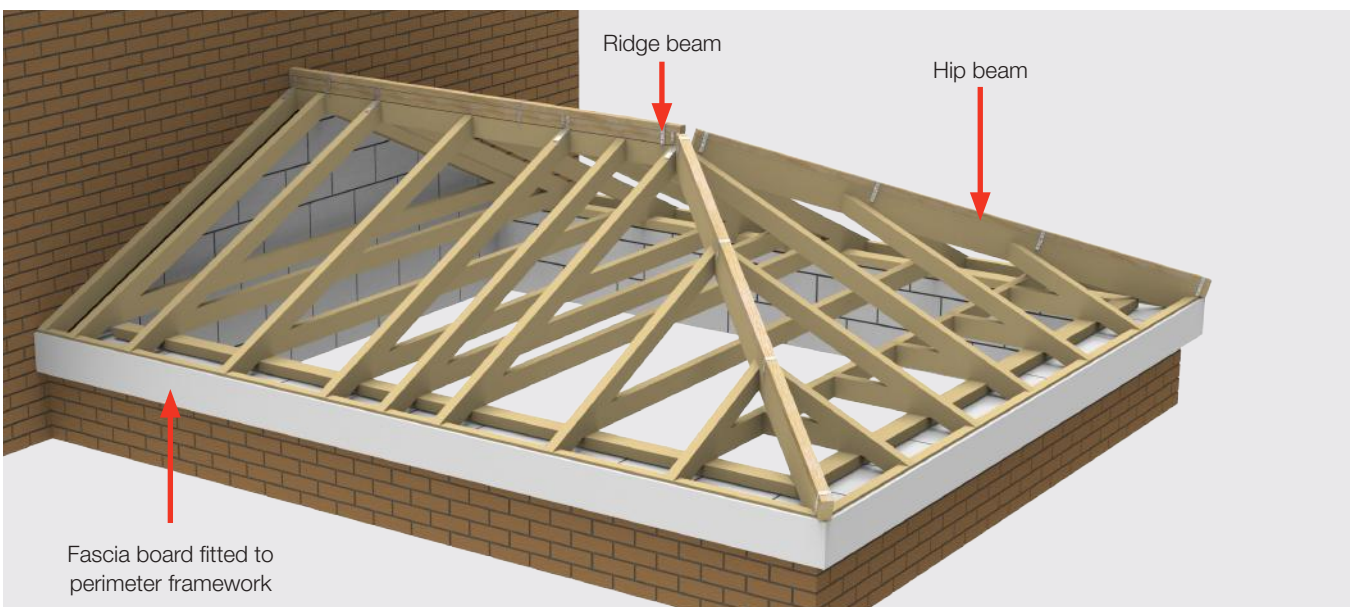

15. INSTALLING HIP ROOFS

15.1

ROOF PANNELLING

If using plywood panels above rafters, the installer should ensure that there is a ventilation gap of 25mm at the apex ridge area to allow for interstitial condensation to escape. At the hip beams please ensure that a minimum gap of 20mm is provided to compensate for both ventilation and panel expansion.



FITTING FELT SUPPORT TRAYS

Fix the universal felt support tray to the plywood ensuring the edge of the tray fits to the edge of the plywood panels at the eaves. Trim the tray at the hip beam as shown - use the edge of the plywood panel as a guide.

Ensure that the trays are overlapped (see page 11 for full details) by at least 100mm to ensure water tightness.

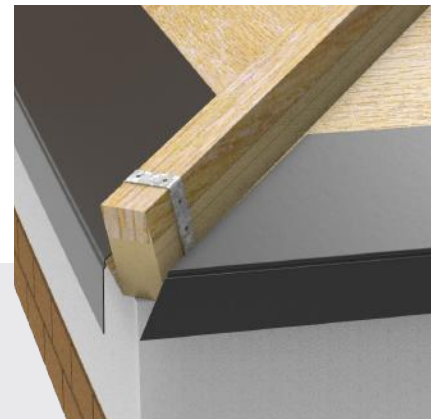

16. INSTALLING EAVES STARTER RAIL

16

DRY FIXING EAVES STARTER RAILS

Please note that the Eaves Bar/Starter Rail, ENVEB, is an integral part of the Envirotile Roof System. It has been specifically designed to provide both the secure patented holding features for the first course of roof tiles as well as added ventilation to the underside of the roof covering which allows for built up condensation and moisture to escape through the viaduct channels.

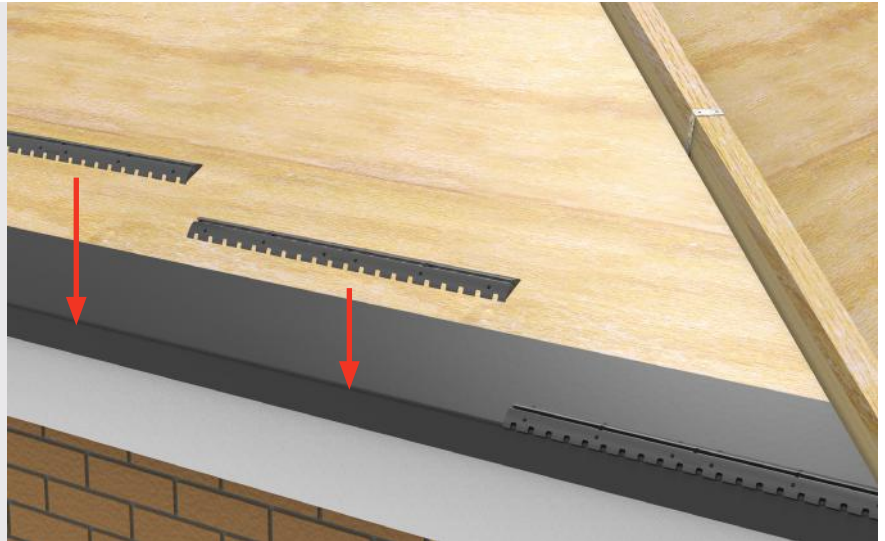

Starting at the right hand edge of each roof face, run through the full roof width with Eave Bar/Starter Rails, ENVEB. Fix in place above the felt support tray along the edge of the plywood panels.

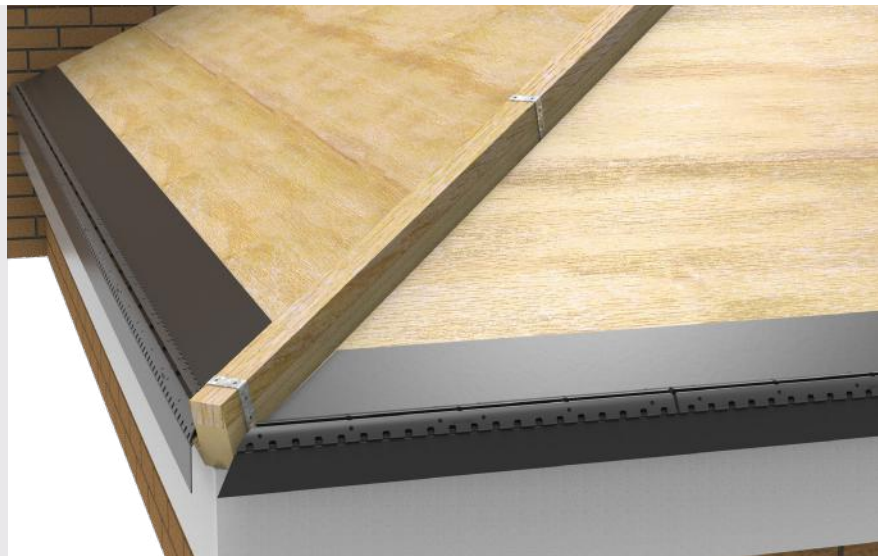

Trim the rail to the edge of the plywood roof panel at each hip

17. INSTALLING ENVIROLAY

17

ENVIROLAY INSTALLATION PROCEDURE

Please note that only Envirolay (ENVIROLAY) is approved for use with Envirotiles. If another underlay is used Eurocell do not guarantee roof performance and all warranties are considered null and void.



ENVIROLAY (ENVIROLAY)

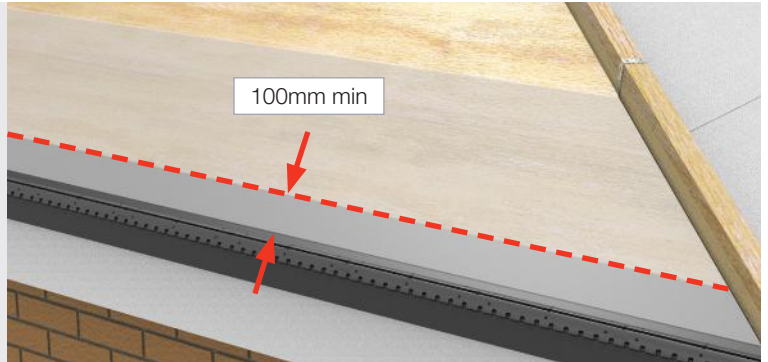

Starting at the right hand roof edge roll out and fix to the plywood roof panels Envirolay (ENVIROLAY) to the full roof face, fixing and securing the roof underlay at 450-600mm centres with clout nails as you go along. Overlap the universal eaves/support tray by a minimum distance of 100mm.

Using a sharp utility knife or equivalent cut the underlay straight at hip edge in line with the panel edge.

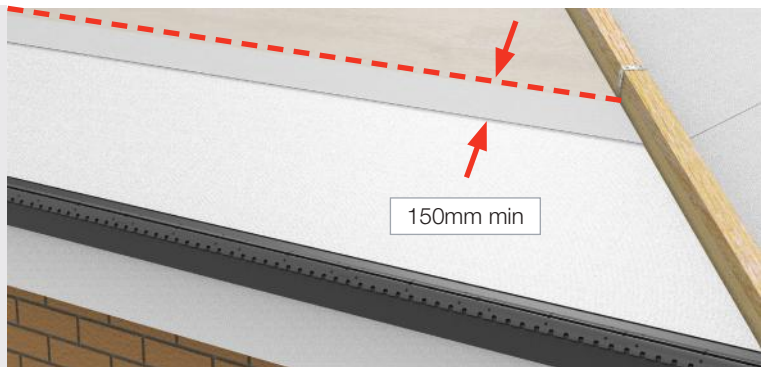

Always overlap above courses by a minimum distance of 150mm.

Use Duo Plus Tape (ENVTAPE) to seal the overlap layers.



DUO PLUS TAPE (ENVTAPE)



ENVIROLAY ABUTMENT WALL DETAIL

Run the Envirolay to the wall face and crease the edge to create a turn up of at least 150mm. Use Duo Plus tape (ENVTAPE) to seal the overlap layers.

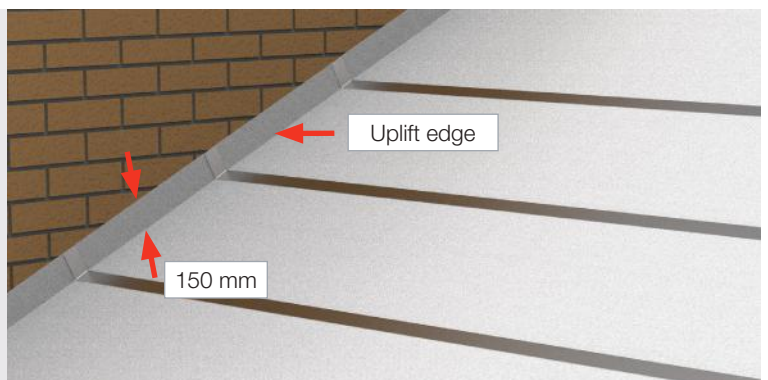

18. INSTALLING ENVIROTILES

18

Laying Envirotiles on a hipped roof face follows the same basic procedure as outlined in pages 20 to 25 of this guide. But there are some differences that need to be considered due to the warm roof structure.

CHECK THAT THE COURSE LINE IS LEVEL ON ALL ROOF FACES

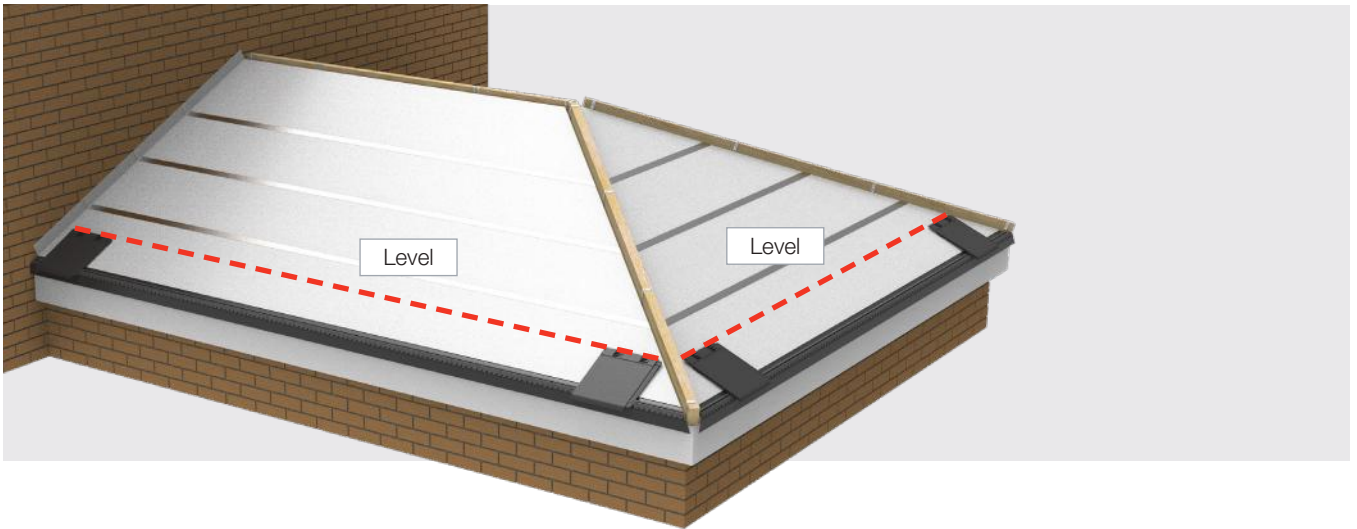

In a warm roof construction the Envirotiles are fixed directly onto the plywood roof face panels. There are no battens so it is very important that the installer checks that the first course line is level. The easiest way to do this is to clip a single tile into the starter rail at each end of each roof face and run a line as shown. Adjust the line so it is level - the starter rail allows for some tile adjustment.

We recommend marking the line on the roof face as a reference.

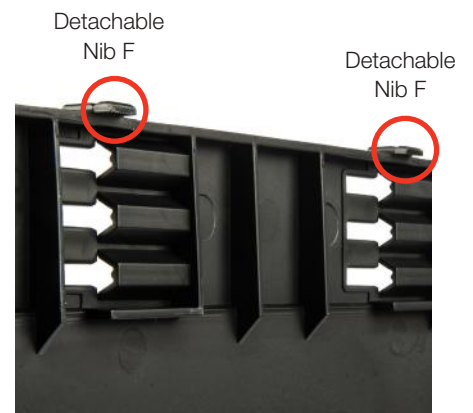

The nibs on the Envirotile raise the back of the tile off the roof face so maintaining a ventilation path.

Starting at the right hand side of the roof face, clip a DOUBLE TILE into the starter rail, locate and position the tile and trim to match the hip as shown. Ensure that you leave 20-25mm of clearance at the edge to allow for ventilation and expansion.

You may wish to use a tile sized paper template to help with this.

It is very important that the tiles are clipped into the starter rail - this is an essential part of installation to ensure that the first course is properly secured.

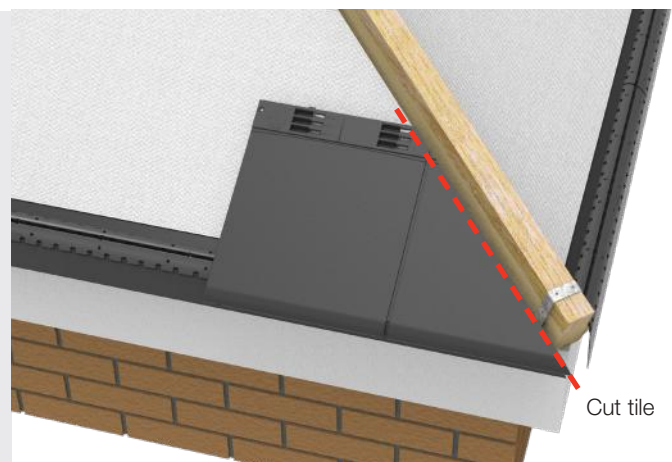

19. SINGLE HIP ROOF FACES

19

Working right to left, fit the Envirotiles in the same way as detailed on pages 20 to 25.

Ensure that the Envirotiles are interlocked and fix the tiles directly to the plywood panels.

Follow the same procedures for the abutment wall side, if required.

Always use double tiles at each end of the course - this is especially important on hipped faces to ensure that the first and last tiles have sufficient fixing points.

Tiles in the course can be single or double

Always ensure that the first tile and the last tile are double tiles.

Once the first course is fitted, securely fix the tiles to the plywood panels.

Using the same procedures detailed for gable wall roof types on page 24, working right to left along the roof face, fit 3 tiles at a time.

Always securely fix each course before fitting the tiles on the course above.

Continue fitting 3 tiles in stages until the roof is covered. On the hip ensure that you always fit a double tile on the hip angle and trim to fit, leaving a 20-25mm gap for ventilation and expansion.

At the left hand side ensure that double tiles are used and trim to fit.

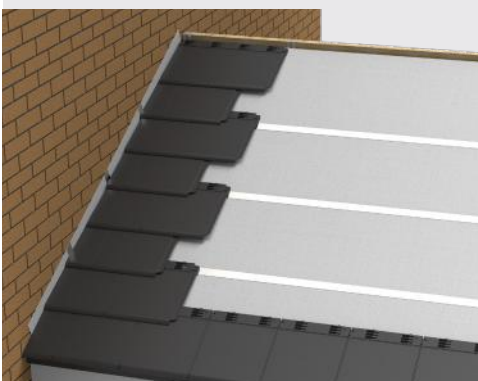
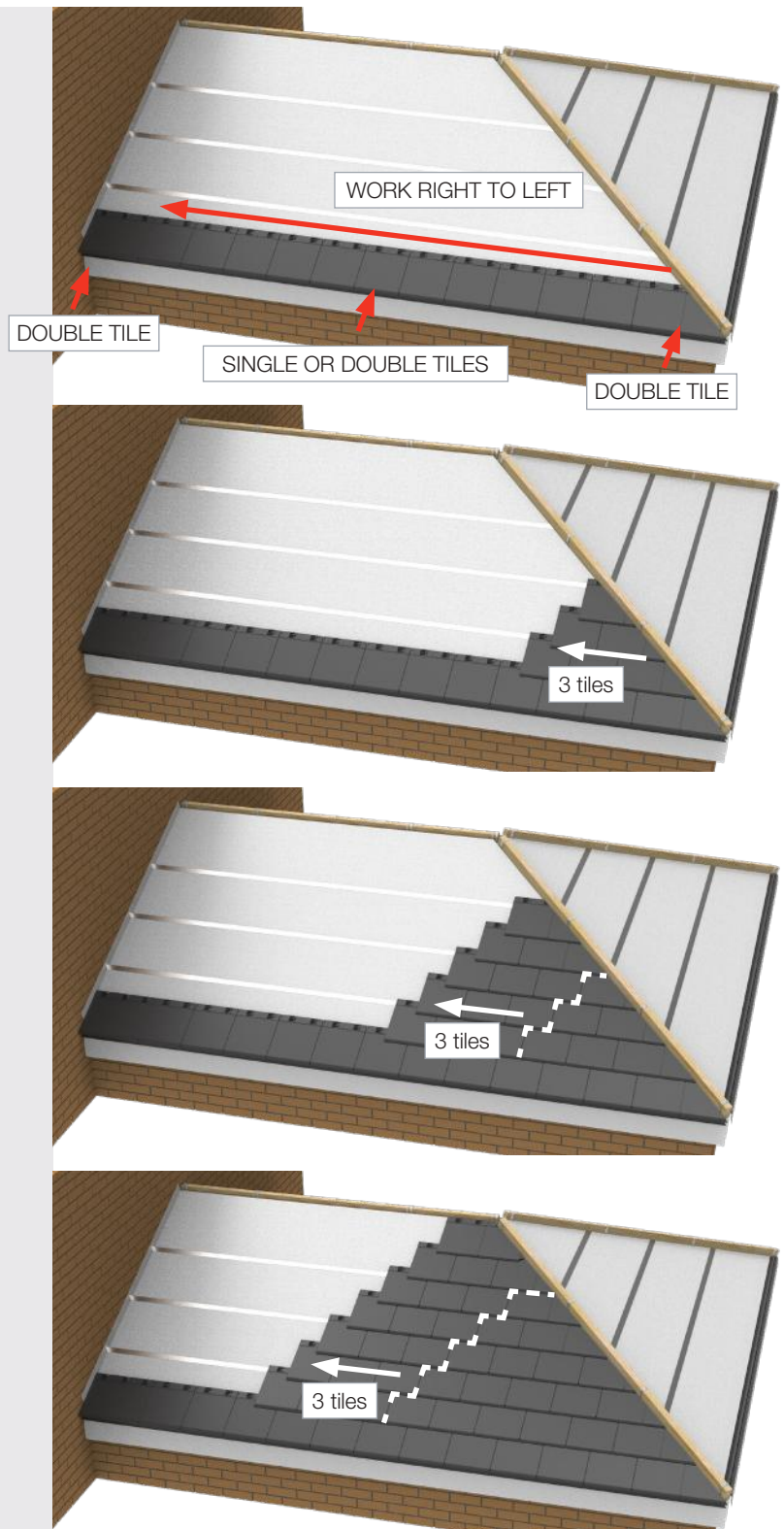

20. DOUBLE HIPPED ROOF FACES

20

On a roof face with a double hip install using the same procedure. Trim the last tile on the left in the same way as the first tile on the right to the hip beam line, leaving a ventilation and expansion gap.

Always ensure that the first tile and the last tile are double tiles.

Once the first course is fitted, securely fix the tiles to the plywood panels.

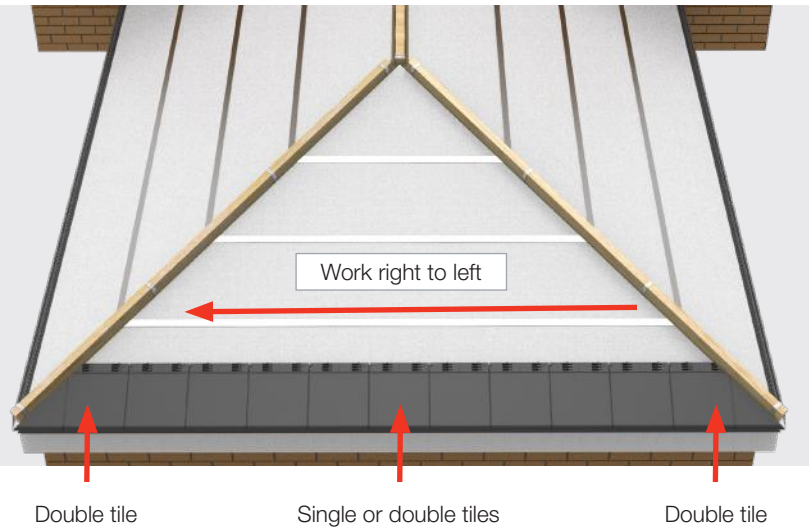

Using the same procedures detailed for gable wall roof types on page 24, working right to left along the roof face, fit 3 tiles at a time.

Always securely fix each course before fitting the tiles on the course above.

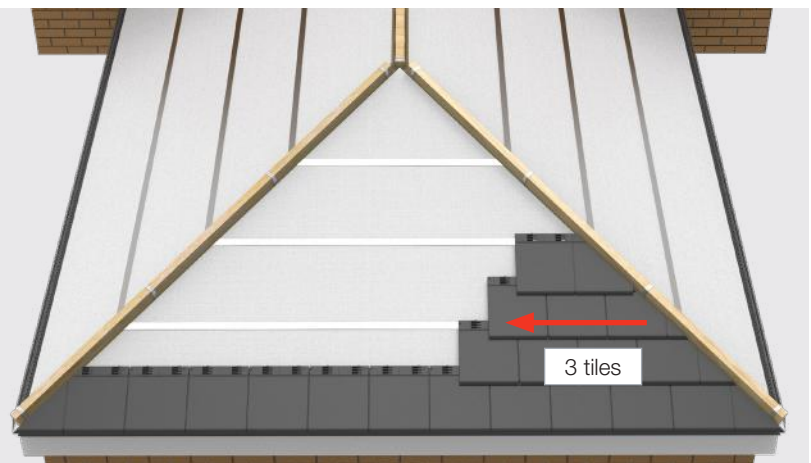

Continue fitting 3 tiles in stages until the roof is covered. On the left hand side ensure that you always fit a double tile on the hip angle. Trim the left hand tiles to the hip beam line, leaving a 20-25mm gap for ventilation and expansion.

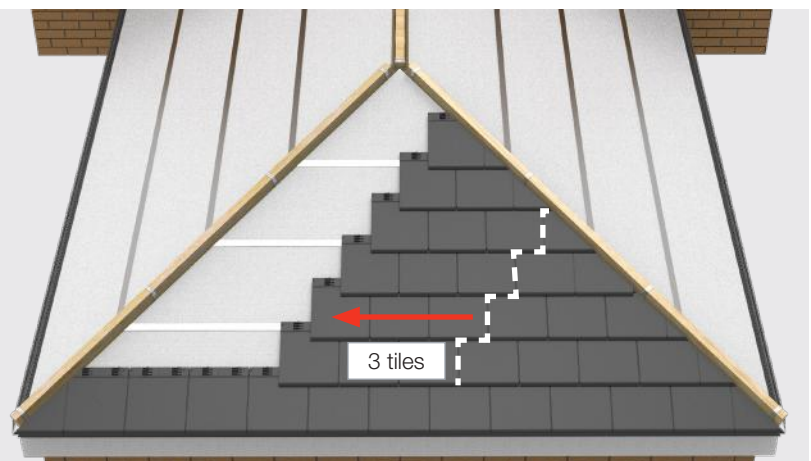

21. VENTILATED RIDGE AND HIP ROLL

21

On a warm roof construction the installer may fit an abutment wall channel or use a simple flashing above or below the tiles.



INSTALLING THE VENTILATED RIDGE ROLL

With the roof tiles installed and securely fixed, the next step is to fit the ventilated ridge roll (ENV330RIDGEROLL) to the main roof ridge and aluminium hip roll (ENV180HIPROLL) to the hips.

Centre the ridge roll on the top ridge batten and lay over the ridge ensuring that the tops of the tiles on either side are covered. Remove the tapes and secure to the tiles.

Repeat for the hip battens and trim to suit.

At abutment walls run the ridge roll to the flashing.



RIDGE ROLL -
ENV330RIDGEROLL

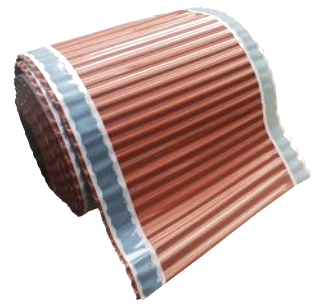

HIP ROLL -
ENV180HIPROLL

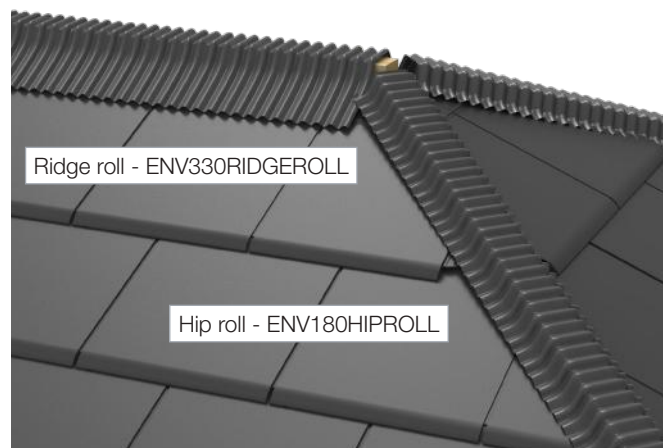
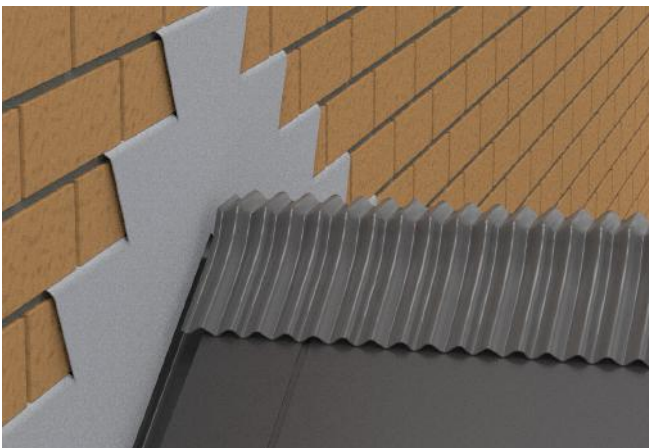

22. INSTALLING THE RIDGE

22

INSTALLING THE RIDGE MOULDINGS

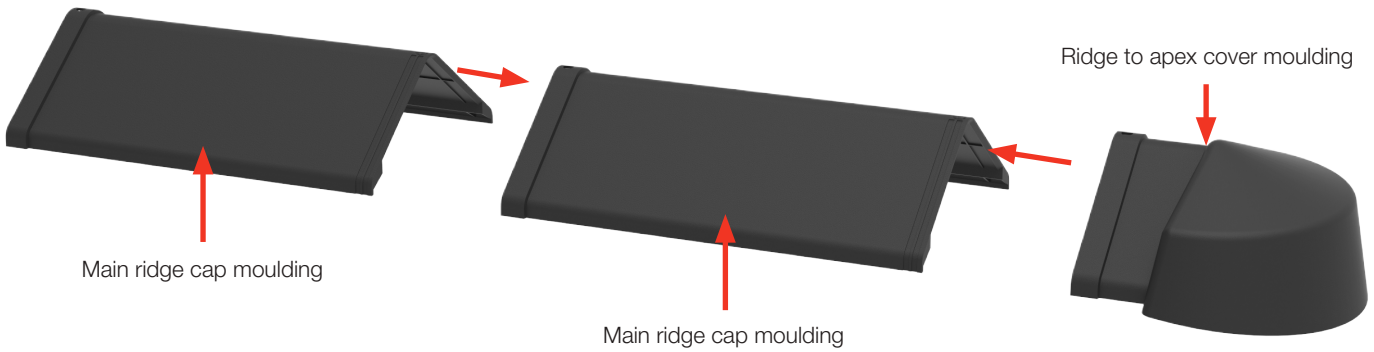

Starting at the right hand side loose fit the ridge to apex cover moulding over the hip to ridge apex. Then loose fit the ridge cap moulding over the ventilated ridge roll and then interlock with the next ridge cap.

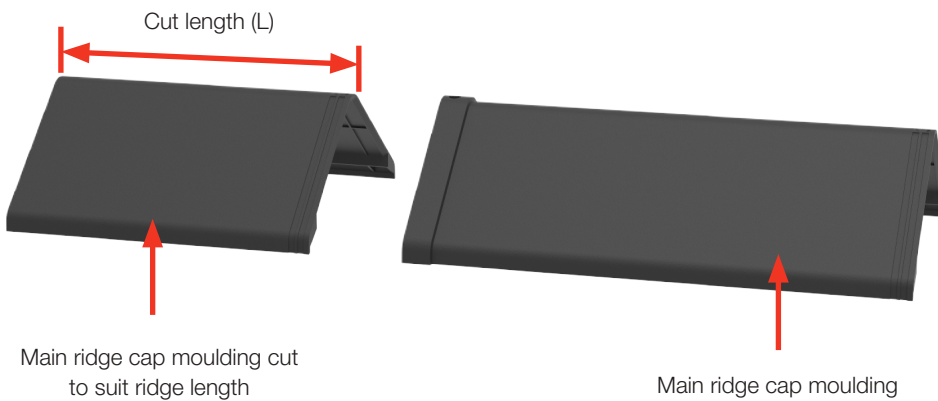

If the cut length (L) is less than half the length of the ridge cap moulding it is recommended that you cut two ridge cap mouldings and space accordingly.

Lay out and interlock the main ridge sections together loosely along the full length of the roof. When correctly aligned permanently fix into place using the bedded batten as a fixture point for the 90mm screw fixings required to permanently fix two ridge sections together. Start the mechanical screw fixing procedure from the right hand side of the roof using the fixing hole (R) on the apex at each end.

Then cut the left hand ridge cap moulding to length.

At an abutment wall cut the ridge cap moulding so there is a 2-3mm gap between the flashing and the cut edge of the cap. Fit and secure.

When fixing cut ridge caps drill a hole to allow for 2 fixings as per full ridge caps.

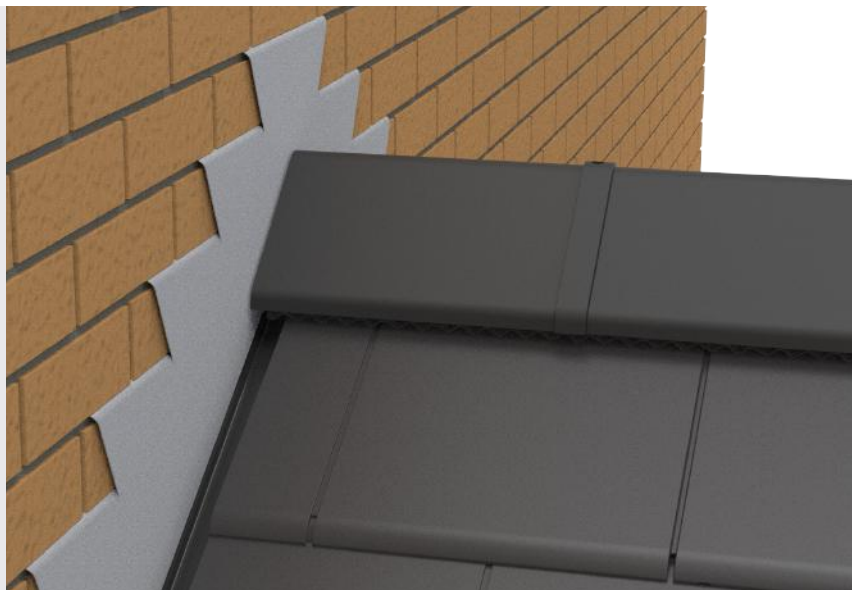

23. INSTALLING THE HIP RIDGE

23

INSTALLING THE HIP RIDGE MOULDINGS

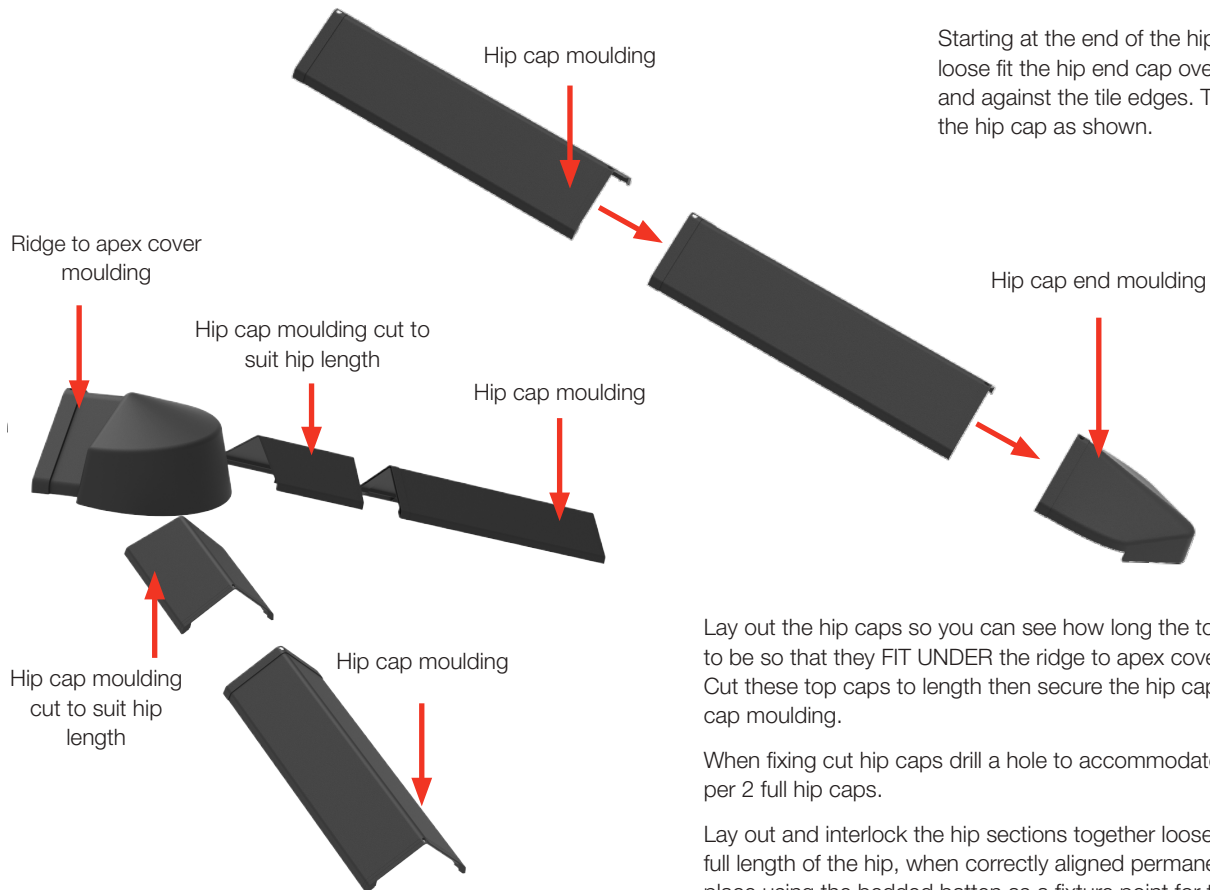

Starting at the end of the hip (low point) loose fit the hip end cap over the hip roll and against the tile edges. Then loose fit the hip cap as shown.

Lay out the hip caps so you can see how long the top caps need to be so that they FIT UNDER the ridge to apex cover moulding. Cut these top caps to length then secure the hip caps and hip end cap moulding.

When fixing cut hip caps drill a hole to accommodate 2 fixings as per 2 full hip caps.

Lay out and interlock the hip sections together loosely along the full length of the hip, when correctly aligned permanently fix into place using the bedded batten as a fixture point for the 90mm length screw fixings required to permanently fix two sections together.

Finally, CUT the ridge to apex cover moulding so that the hip cap mouldings are covered. Then secure the ridge to apex cover.

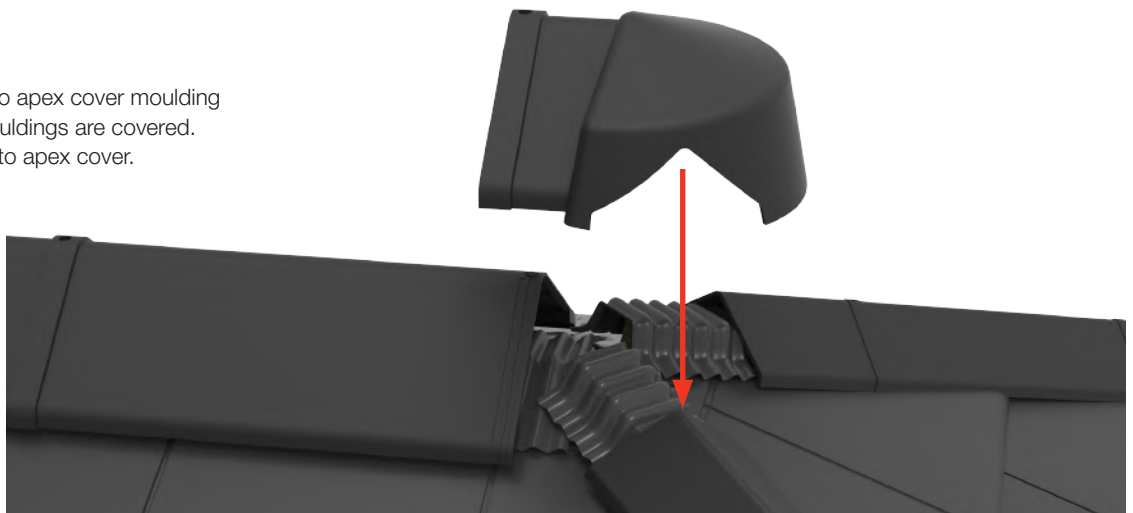

24. FITTING THE GUTTERS

24

With all tiles installed and secured, the gutters and downpipes can be fitted.



DON'T FORGET YOUR PROJECT COMPLETERS:

- ▶ Timber
- ▶ Roofing Membranes
- ▶ Fixings
- ▶ Eurocell Roofline
- ▶ Marshall Tufflex Guttering
- ▶ Felt Support Trays
- ▶ Silicones and Sealants
- ▶ Cleaning Products
- ▶ Tools

25. ENVIROTILE SLATE COMPONENTS LIST

25

Envirotile Slate Single – Size: L:365mmxW:325mmxD:11mm

Slate Grey **ENVLSLSSG**

Dark Brown **ENVLSLBR**

Terracotta **ENVSLSTR**

Anthracite Grey **ENVLSLBBK**

Envirotile Slate Double – Size: L:365mmxW:630mmxD:11mm

Slate Grey **ENVSLDSG**

Dark Brown **ENVSLDBR**

Terracotta **ENVSLDTR**

Anthracite Grey **ENVSLDBBK**

Envirotile Slate Half – Size: L:365mmxW:175mmxD:11mm

Slate Grey **ENVSLHSG**

Dark Brown **ENVSLHBR**

Terracotta **ENVSLHTR**

Anthracite Grey **ENVSLHBBK**



Ridge Cap – Size: L:425mmxW:245mmxH:105mm

Slate Grey **ENVSLRCSG**

Dark Brown **ENVSLRCBR**

Terracotta **ENVSLRCTR**

Anthracite Grey **ENVSLRCBK**

Gable End Cap – Size: L:28mmxW:325mmxH:178mm

Slate Grey **ENVSLGEPG**

Dark Brown **ENVSLGEPBR**

Terracotta **ENVSLGEPTR**

Anthracite Grey **ENVSLGEPBK**

Hip Cap – Size: L:425mmxW:165mmxH:70mm

Slate Grey **ENVSLHCSG**

Dark Brown **ENVSLHCBR**

Terracotta **ENVSLHCTR**

Anthracite Grey **ENVSLHCBK**

Hip End Cap – Size: L:180mmxW:165mmxH:90mm

Slate Grey **ENVSLHECSG**

Dark Brown **ENVSLHECBR**

Terracotta **ENVSLHECTR**

Anthracite Grey **ENVSLHECBK**

Ridge To Apex – Size: L:252mmxW:292mmxH:145mm

Slate Grey **ENVSLRACSG**

Dark Brown **ENVSLRACBR**

Terracotta **ENVSLRACTR**

Anthracite Grey **ENVSLRACBK**



26. ENVIROTILE STANDARD COMPONENTS LIST

26

Envirotile Standard Single – Size: L:365mmxW:325mmxD:11mm

Anthracite Black **ENVSTSAG**

Slate Grey **ENVSTSGY**

Dark Brown **ENVSTSBR**

Terracotta **ENVSTSTR**

Envirotile Standard Double – Size: L:365mmxW:630mmxD:11mm

Anthracite Black **ENVSTDAG**

Slate Grey **ENVSTDGY**

Dark Brown **ENVSTDBR**

Terracotta **ENVSTDTR**

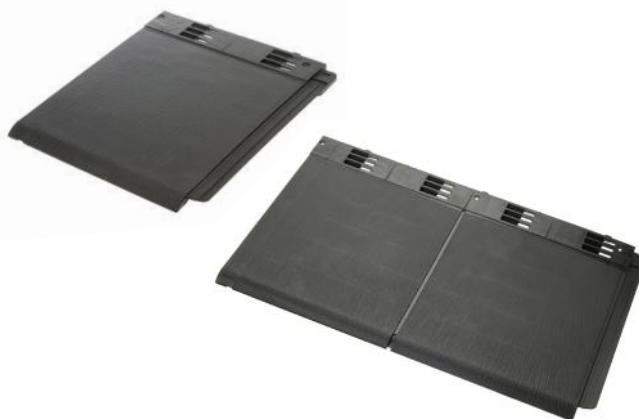

Ridge Cap – Size: L:475mmxW:300mmxH:170mm

Anthracite Black **ENVSTRCAG**

Slate Grey **ENVSTRCGY**

Dark Brown **ENVSTRCBR**

Terracotta **ENVSTRCTR**

Gable End Cap – Size: L:30mmxW:300mmxH:170mm

Anthracite Black **ENVSTGECAG**

Slate Grey **ENVSTGECGY**

Dark Brown **ENVSTGECBR**

Terracotta **ENVSTGECTR**

Hip Cap – Size: L:425mmxW:150mmxH:70mm

Anthracite Black **ENVSTHCAG**

Slate Grey **ENVSTHCGY**

Dark Brown **ENVSTHCBR**

Terracotta **ENVSTHCTR**

Hip End Cap – Size: L:180mmxW:150mmxH:70mm

Anthracite Black **ENVSTHECAG**

Slate Grey **ENVSTHECGY**

Dark Brown **ENVSTHECBR**

Terracotta **ENVSTHECTR**

Ridge To Apex – Size: L:280mmxW:300mmxH:170mm

Anthracite Black **ENVSTRTAAG**

Slate Grey **ENVSTRTAGY**

Dark Brown **ENVSTRTABR**

Terracotta **ENVSTRTATR**



27. ENVIRO TILE STANDARD/SLATE COMPONENTS LIST

27

Standard Lowline Vent –
Size: L:365mmxW:325mmxD:11mm + Profile

Anthracite Grey **ENVSTLVTAG**

Grey **ENVSTLVGY**

Brown **ENVSTLVTBR**

Terracotta **ENVSTLVTRR**

Standard Cowl Vent –
Size: L:365mmxW:325mmxD:11mm + Profile

Anthracite Grey **ENVSTCVTAG**

Grey **ENVSTCVGY**

Brown **ENVSTCVTBR**

Terracotta **ENVSTCVTRR**



3m Dry Verge – Size: L:3000mm

Anthracite Grey **ENV3MDVAG**

Brown **ENV3MDVBR**

Terracotta **ENV3MDVTR**

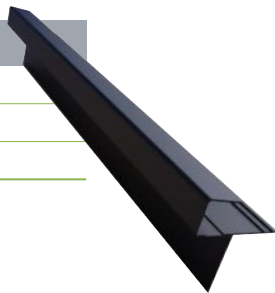

Square to Round Pipe Adaptor – Size: 110mm

Square to Round Pipe Adaptor **ENVSRPA110**



Ventilated Eaves Bar/Starter Rail –
Size: L:600mmxW:48mmxH:12mm

Eave Bar **ENVEB**



Flexitube and clips – Size: 112mm

Flexitube and clips **ENVFXCL**

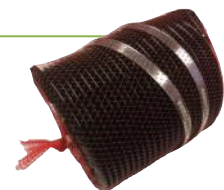

Dry Verge Bracket

Anthracite Grey **ENVVBBAG**

Brown **ENVVBBBR**

Terracotta **ENVVBBTR**



27. ENVIROTILE STANDARD/SLATE COMPONENTS LIST

27

Screw Cover Cap – Size: Large

Anthracite Grey **ENVSCCLAG**

Grey **ENVSCCLGY**

Brown **ENVSCCLBR**

Terracotta **ENVSCCLTR**

Screw Cover Cap – Size: Small

Anthracite Grey **ENVSCCSAG**

Grey **ENVSCCSGY**

Brown **ENVSCCSBR**

Terracotta **ENVSCCSTR**



Aluminium Hip Roll – Size: Dx180mmxL:6000mm

Aluminium Hip Roll 180mm **ENV180HIPROLL**

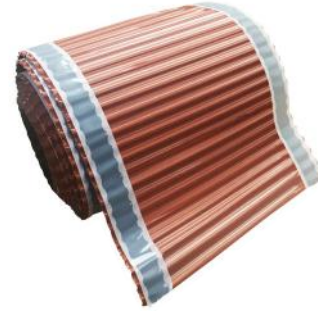

Fixings

90 x 6.3mm SS Pozi Pan Self Tapping Screw **ENVSCREW90**

32 x 4.2mm SS Pozi Pan Self Tapping Screw **ENVSCREW32**

Ventilated Ridge Roll – Size: Dx330mmxL:6000mm

Ventilated Ridge Roll 330mm **ENV330RIDGEROLL**



Duo Plus Tape – Size: Dx40mmxL:6000mm

Duo Plus Tape **ENVTAPE**



Enviroloy – Size: Size: Dx130mmxL:25000mm

Enviroloy **ENVIROLAY**

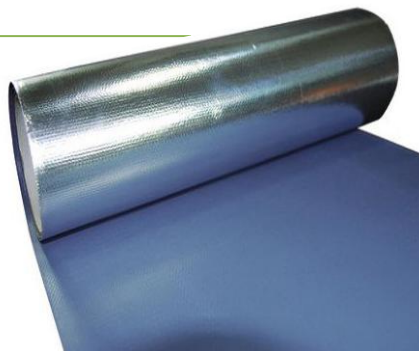

DESIGN GRID

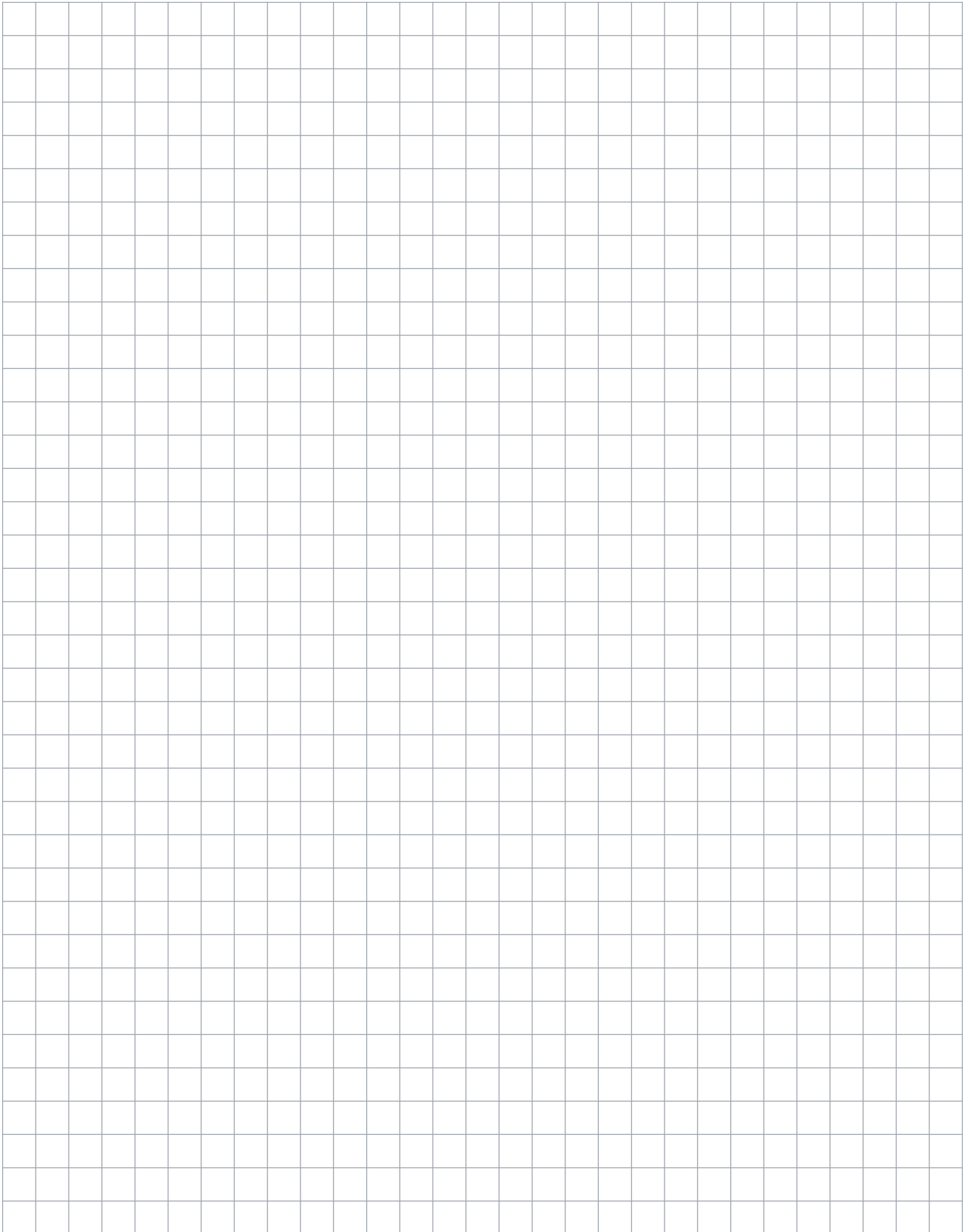

CONTACT

For further information, contact the Eurocell Technical Team on **0333 777 3047**. Visit **eurocell.co.uk** to find installation guides and videos for Eurocell products.

